

Review

Cosmic Rays: A Review for Astrobiologists

Franco Ferrari and Ewa Szuszkiewicz

Abstract

Cosmic rays represent one of the most fascinating research themes in modern astronomy and physics. Significant progress is being made toward an understanding of the astrophysics of the sources of cosmic rays and the physics of interactions in the ultrahigh-energy range. This is possible because several new experiments in these areas have been initiated. Cosmic rays may hold answers to a great number of fundamental questions, but they also shape our natural habitat and influence the radiation environment of our planet Earth. The importance of the study of cosmic rays has been acknowledged in many fields, including space weather science and astrobiology.

Here, we concentrate on the astrobiological aspects of cosmic rays with regard to the enormous amount of new data available, some of which may, in fact, improve our knowledge about the radiation of cosmic origin on Earth. We focus on fluxes arriving at Earth and doses received, and will guide the reader through the wealth of scientific literature on cosmic rays. We have prepared a concise and self-contained source of data and recipes useful for performing interdisciplinary research in cosmic rays and their effects on life on Earth. Key Word: Radiation. *Astrobiology* 9, 413–436.

1. Introduction

COSMIC RAYS (CR) represent a fascinating subject of research that is of growing interest within the scientific community. With the next generation of cosmic ray detectors, such as the Pierre Auger Cosmic Ray Observatory, whose active detectors have been recording events in the energy range from 10^{18} eV to the very highest values (Abraham *et al.*, 2004), there is hope that some of the questions posed by these cosmic particles will soon find some satisfactory answers. It should be noted, however, that the attention to CR is not restricted only to the traditional fields of high-energy physics and astroparticles; this article, for instance, is the result of the authors' efforts to investigate the mutagenic effects of cosmic rays on cells. To this purpose, it is necessary to characterize with precision the fluxes and intensities of particles that arrive at Earth's surface as an effect of the interaction of CR with the magnetosphere and the atmosphere of Earth. The fact that CR are not only interesting in their own right but also from an applicative point of view is testified to by the attention that they receive by space weather researchers (Dorman, 2004) and astrobiologists, who study their possible impact on the evolution of living organisms.

The effects of natural ionizing radiation on the rate of mutation of organisms have been discussed as early as the 1920s. Babcock and Collins (1929) concluded that this radiation is an important factor in that it helps to control the rate at which new inherited characteristics originate in animals and plants. The idea that the evolution of life is influenced by irradiation sources was presented by Sagan and Shklovskii (1966). Radiobiological experiments in space were reviewed by Horneck (1992) and Horneck *et al.* (2001). Belisheva *et al.* (2002) studied the dynamics of the morphogenetic state of cell cultures in connection with the solar activity. Satta *et al.* (2002) presented the results of their *Pulex* experiment, which was aimed at understanding the effect of low-dose ionizing radiation on living organisms. The long-term survival of viable organisms has been investigated in realistic environments within terrestrial minerals and on Mars by Kminek *et al.* (2003), who found that such environments limit the survival of viable bacterial spores over long periods. Biological effects of galactic cosmic rays were also discussed by Griebmeier *et al.* (2005) in the context of extrasolar Earth-like planets. Medvedev and Melott (2007) addressed the question of how cosmic ray flux may affect biodiversity.

This review is aimed at a readership of astrobiologists. Of course, there are already excellent reviews and even books

about CR, but they are mainly devoted to pure research in CR. Moreover, it should be kept in mind that not all aspects of CR have been clarified, and many questions remain unanswered so that, for a reader who is not a specialist in this field, it may be difficult to separate facts from hypotheses. After almost a century since the discovery of CR, in fact, a huge amount of scientific literature has been devoted to them, and it is not always easy to extract from it the necessary information for those who wish to approach the subject for the first time. Moreover, many of the publications concerning fluxes arriving at Earth and the doses received due to CR, which is exactly what is relevant to an astrobiologist, appeared some time ago, and there is a need to revisit some of these issues again. In addition, quite often in the scientific literature on CR, concepts such as the integral vertical intensity or the differential integrated flux¹ are encountered (see for example Eidelman *et al.*, 2004; or Rossi, 1948). These terms may be somewhat puzzling or exotic to some, if not accompanied by proper definition.

In light of this, we prepared this article such that it is a compact, though self-contained, introduction to CR. Priority has been given to well-established facts that are likely not to become obsolete in a few years due to rapid progress in this field. For example, the puzzles raised by the existence of ultrahigh-energy cosmic rays with energy of 10^{19} eV or higher, such as the mystery of their origins or the apparent violation of the theory of relativity associated with them, are briefly mentioned. Hopefully, these puzzles will be solved with the next generation of cosmic ray detectors. In this work, preference has been given to current knowledge of the data concerning the physical parameters—*e.g.*, types of radiation, delivered effective doses and dose rates, fluxes and intensities of incoming particles—that characterize radiation to which organisms on Earth are exposed as a result of CR. These data are certainly of interest for those who work in astrobiology and life sciences. Cosmic rays are, in fact, the source of an almost uniform background of ionizing radiation present everywhere on Earth. Most of their energy arrives at the ground in the form of the kinetic energy of muons. The latter particles are very penetrating and can travel for kilometers in water and for hundreds of meters through rock. Since ionizing radiation is mutagenic, it is very likely that radiation of cosmic origin has, in some way, shaped the evolution of life on our planet and generated some adaptive response in cells.

We have attempted here to explain in detail, and with the aid of figures, technical terms used in the current scientific literature. The definitions of these terms and the recipes for calculating the desired quantities are placed in a separate Appendix at the end of the paper.

As already mentioned, this article is self-contained, but of course it is far from complete in that it is impossible to cover all the literature in existence on CR. To integrate the material presented here, the interested reader may wish to consult other sources, such as Gaisser (1990), Sokolsky (1989), Stanev

(2004), Greider (2001), and Friedlander (2000). The first of these three books is focused on high-energy cosmic rays. *Cosmic Rays and Particle Physics* by Thomas K. Gaisser (Gaisser, 1990) is a classical reference that addresses the fundamental questions of CR physics—the origin of CR, acceleration mechanisms, and CR propagation in space. It also describes the interactions of CR with the atmosphere and Earth. The book is devoted mainly to astrophysicists and particle physicists. Similar in spirit is Pierre Sokolsky's volume *Introduction To Ultrahigh Energy Cosmic Ray Physics (Frontiers in Physics)* (Sokolsky, 1989) and Todor Stanev's *High Energy Cosmic Rays* (Stanev, 2004). These works also present modern experimental techniques and discuss results obtained by the present detectors. The last two books, *Cosmic Rays at Earth*, edited by P.K.F. Greider (Greider, 2001), and *Thin Cosmic Rain: Particles from Outer Space* by Michael W. Friedlander (Friedlander, 2000) speak to biological and medical aspects of cosmic radiation in addition to fundamental topics of CR research.

For further reading, we suggest Mewaldt (1996), Eidelman *et al.* (2004), Biermann and Sigl (2001), Cronin (1999), Battistoni and Grillo (1996), and Anchordoqui *et al.* (2003). In particular, we recommend Mewaldt (1996) for a concise and less technical short reference of the most important properties of CR, and reviews on CR of the *Particle Data Group* (Eidelman *et al.*, 2004) and the more recent Yao *et al.* (2006), which includes much updated information on CR. An extensive list of CR sources and a discussion of the origin and physics of CR can be found in Battistoni and Grillo (1996), Cronin (1999), Biermann and Sigl (2001), and Anchordoqui *et al.* (2003). The astrophysical origins are described in detail in Torres and Anchordoqui (2004), and the latest experimental results has been reviewed in Bergman and Belz (2007).

2. Cosmic Rays and Natural Background Radiation

2.1. A brief introduction to cosmic rays

Cosmic rays, which were first discovered by Victor Hess in 1912 (Hess, 1912), are charged particles accelerated to very high energies by astrophysical sources located anywhere beyond the atmosphere of the Earth. In space, 89% of CR consist of protons, $\sim 10\%$ consist of α particles, and $\sim 1\%$ consist of heavier nuclei.² Electrons undergo strong energy losses due to synchrotron and inverse Compton scattering losses. The contribution of electrons to CR is about 1% (Clem *et al.*, 1995). The ratio of positrons to electrons is about 10% (Clem *et al.*, 1995). The ratio of protons to antiprotons in CR beams has been discussed in Amenomori *et al.* (1995) and Orito *et al.* (1995). All stable charged particles and nuclei with lifetimes of order 10^6 years have been detected. More details on the composition of CR can be found in Eidelman *et al.* (2004), Yao *et al.* (2006), and references therein.

Within the flux of incoming particles, different components can be distinguished. The most relevant are galactic CR

¹In the recent literature one encounters quantities like these very often; but, to avoid technical terms, they are simply called fluxes or intensities, even if their units do not coincide with those which are appropriate for flux or intensity.

²These data are taken from Mewaldt (1996). Of course, as it always happens in the case of experimental data, there is some uncertainty due to measurement errors. For this reason, different authors report slightly different values, as in the case of O'Brien *et al.* (1996), which gives 95% for protons, 3.5% for α particles and 1.5% for all the rest.

(GCR), solar energetic particles (SCR), and anomalous CR (ACR). GCR originate from sources located outside the Solar System but generally in our galaxy. The most energetic ones may come from extragalactic sources. It is believed that GCR are a consequence of astrophysical events, such as stellar flares, stellar coronal mass ejections, supernova explosions and their remnants, particle acceleration by pulsars, and jets from black holes. Very often, the term *cosmic rays* refers only to GCR (Mewaldt, 1996). The smallest energy of GCR, which was detected by Voyager, is a few tens of MeV (Seo *et al.*, 1994). In general, the motion of particles whose kinetic energy is about 5 GeV or less is affected by the small-scale plasma wave turbulence caused by the solar wind. Additionally, the trajectories of such low-energy particles execute a drift due to the large-scale heliosphere magnetic field. Both effects of turbulence and magnetic fields vary (quasi) periodically with a (quasi) period of about 22 years³ due to the solar activity. As a consequence, the spectra of GCR in the low-energy range are modulated in space and time. The modulation in time is a (quasi) periodic variation of CR flux levels, which is anticorrelated to the solar activity. The modulation in space causes the decrease of the GCR flux with decreasing particle energies and decreasing heliocentric distance (Fichtner 2001, Eidelman *et al.*, 2004). The action of the solar wind partially prevents the lower-energy particles from penetrating the inner Solar System. In addition to the solar wind and the heliosphere magnetic field, the CR flux is reduced by the geomagnetic field, the effects of which depend on latitude and are described in some detail in Subsection 3.4. A third filter against CR is provided by Earth's atmosphere, which is able to stop particles with energies below approximately half a GeV. Detailed information on the interaction of GCR with the magnetic fields of the Sun and Earth can be found in O'Brien *et al.* (1996) and references therein. Here, we note a few important facts about the effects on CR of the galactic magnetic fields, which are generated by the spinning of the Milky Way. These fields are relatively weak because the average magnetic field in our galaxy is of the order of 10^{-10} T. Since CR consist of charged particles that travel huge distances, however, even tiny magnetic fields are able to bend their trajectories in a relevant way. At this point it should be noted that there are two different components in the magnetic fields of our galaxy: a regular one and a turbulent one (see Rand and Kulkarni, 1989). The strengths and directions of the magnetic fields that belong to the turbulent component are random (Rand and Kulkarni, 1989; Clay *et al.*, 1998). Due to this randomness, the trajectories of CR are randomly bent. As a consequence, the flux of CR that arrives at Earth is also random or, more precisely, isotropic. For this reason, it is not easy to ascertain where GCR are coming from. Besides being isotropic, the particle flux is approximately constant in time as well, so that GCR form an almost uniform background of ionizing radiation that strikes the atmosphere of Earth. It should be noted at this point that the flux of particles below the energy of 10 GeV is modulated by the 22-year

solar cycle. At the surface of Earth, the measured flux of low-energy particles has an additional time dependence due to weather conditions (see for example Bhattacharyya, 1976, and Olbert, 1953).

Cosmic rays of energies up to 10^{21} eV have been observed (Bergman and Belz, 2007). These are considerable energies for a microscopic particle. For example, the upper energy limit of 10^{21} eV corresponds in the International System of Units (SI units) to approximately 160 joules. This is comparable to the kinetic energy of a ball of 0.8 kg thrown at the speed of 50 km/h. The origin of such ultrahigh-energy CR (UHECR) is so far unknown, but there are strong hints that they are produced outside our galaxy. Candidate sources of UHECR could be relativistic plasma jets from supermassive black holes (Rachen and Bierman, 1993) or explosions of galactic nuclei, but other possible sources have been proposed, such as magnetic monopoles (see for example Bhattacharjee and Sigl, 2000). The fact that the magnetic fields present in the Milky Way are not able to trap CR of that energy suggests that UHECR are of extragalactic origin. Indeed, protons of energy higher than 10^{15} eV are able to escape galactic confinement.⁴ Therefore, if protons of energies of 10^{19} eV or higher were produced by sources located in our galaxy, they would escape from it in all possible directions and follow trajectories that are almost straight lines. As a consequence, the ultrahigh-energy protons that reach Earth should arrive along directions that are approximately parallel to the galactic plane. However, this conclusion is not confirmed by observations [see Cronin *et al.*, 1997; UNSCEAR Report, Annex B (UNSCEAR, 2000a), and references therein]. Observations show, in fact, that the spatial distribution of ultrahigh-energy protons is isotropic, so that their directions are not aligned with the galactic plane. This, of course, strongly suggests that UHECR are of extragalactic origin.

On the other hand, there is at least one argument that points out that the sources of UHECR are not far from our galaxy. In fact, it has been noted that protons of energies above $5 \cdot 10^{19}$ eV would lose their energy by interacting with the photons of the microwave (Big Bang) background. This effect was predicted in 1966, one year after the detection of the microwave background radiation, by Kenneth Greisen (Greisen, 1966) and by Vadim Kuz'min and Georgi Zatsepin (Zatsepin and Kuz'min, 1966). The energy threshold of $5 \cdot 10^{19}$ eV is called the GZK limit, from the names of its discoverers. Protons with energies above that threshold are slowed down during their travel to Earth by the mechanism of energy loss pointed out by Greisen, Kuzmin, and Zatsepin. That is, until their energy falls below the GZK limit. This mechanism is so effective that, in practice, protons with energies higher than $5 \cdot 10^{19}$ eV should not be observed on Earth if their source is located at distances greater than 50 Mpc⁵.

³The 22-year cycle is the solar magnetic cycle, which lasts twice as long as the sunspot 11-year cycle because the polarity of the solar magnetic field returns to its original value every two sunspot cycles.

⁴In the case of heavier nuclei, the threshold energy for escaping galactic confinement is higher than that of protons. It is for this reason that one observes a greater proportion of heavier nuclei with respect to protons in CR with energy above 10^{15} eV.

⁵Mpc stands for megaparsec: 50 Mpc is approximately 150 million light years. This is about 1500 times the diameter of a galaxy, but it is not a big distance in comparison with the cosmic scale of distances.

Since ultrahigh-energy protons have been detected, however, the implication is that they originate from sources within a range of 50 Mpc. Yet the known cosmic objects that could accelerate protons to such high energies are at a distance of at least 100 Mpc or more. To date, there is no known explanation why cosmic ray protons with energies higher than $5 \cdot 10^{19}$ eV have been detected on Earth, while their formidable sources, which should be relatively near to us, remain invisible. These contradictions comprise the GZK paradox, and though a detailed discussion of the GZK paradox is outside the goals of this review, the interested reader may wish to consult Cronin (2004), Dedenko and Zatsepin (2005), and Trimble *et al.* (2006). An interesting proposal for a solution of the GZK paradox has been presented by Farrar and Piran (2000), who proposed that the source of UHECR could be located at a relatively small distance from Earth, of the order of a few Mpc. These authors assume that the strength of the magnetic fields in extragalactic space amounts to a few tenths of μG , a value an order of magnitude greater than the value of 10^{-10} T given previously ($1 \mu\text{G} = 10^{-10}$ T) but still compatible with the current observational and theoretical constraints. It is also big enough to allow the diffusion of UHECR. With the help of numerical simulations and theoretical arguments, Farrar and Piran (2000) argued that the source of most UHECR that arrive at Earth may be Cen A, a powerful radio galaxy situated at a distance of 3.4 Mpc.

Here, remaining components of CR are considered. Energetic solar events, such as solar flares, are able to accelerate particles up to some GeV very efficiently within 10 seconds. The SCR are mainly protons, heavier nuclei, and electrons. A detailed account of solar energetic particles may be found in O'Brien *et al.* (1996), Ryan *et al.* (2000), and UNSCEAR Report Annex B (UNSCEAR, 2000a). Moreover, there is a more recent monograph in which the results of SCR investigations are summarized (Miroshnichenko, 2001). Most of the charged particles emitted by the Sun are not energetic enough to arrive at Earth's surface (Shea and Smart, 2000), so they will not be discussed here. The majority of the mutagenic effects of the Sun on Earth is due to the emitted ultraviolet radiation. However, SCR are relevant in the human exploration of space, where the shield against radiation of the atmosphere is not present or is less effective.

Finally, it is worth addressing the case of ACR. As mentioned previously, the flux of low energetic GCR decreases with decreasing particle energies due to the effects of the solar wind and the magnetic field present in the heliosphere. It should be said, however, that this is not entirely true, because CR have an anomalous component at kinetic energies below ~ 200 MeV nucl^{-1} , whose flux is not strictly monotonically decreasing with decreasing energies (Fichtner, 2001). The spectrum of these ACR is mainly characterized by ions of elements, which are difficult to ionize, including He, N, O, Ne, and Ar. ACR also have a relatively low energy, up to a few hundreds of MeV (Klecker *et al.*, 1998). It is thus improbable that CR of such a low energy could originate from the violent phenomena that produce GCR. The most recent theory of ACR origin, as published by McComas and Schwadron (2006), suggests that they are produced at the flanks of the termination

shock but not at the blunt nose of it. The termination shock is the location in space where the solar wind becomes subsonic. The importance of the flattened shape of the termination shock was realized after the unsuccessful attempt of Voyager 1 to measure the ACR while the craft was passing through the blunt nose. Voyager 2 crossed the solar termination shock in the second half of 2007 and reported that the intensity of 4–5 MeV protons accelerated by the shock was 3 times that measured by Voyager 1. Voyager 2 did not, however, find the source of ACR at the shock, confirming with that the observations of Voyager 1. This suggests that ACR are generated elsewhere on the shock or in the heliosheath (see for instance Cummings *et al.*, 2008).

2.2. Interaction of cosmic rays with Earth's atmosphere

When CR arrive near Earth, they hit the nuclei of the atoms of the atmosphere, in particular nitrogen and oxygen, and produce secondary particles. The first interaction of the CR primary particle takes place in the top 10% of the atmosphere (Clay *et al.*, 1997). The most relevant reactions,⁶ remembering that approximately 90% of CR consist of protons, are:

$$pp \rightarrow pn\pi^+ \quad \text{or} \quad pp \rightarrow pp\pi^0 \quad (1)$$

$$pn \rightarrow pp\pi^- \quad \text{or} \quad pn \rightarrow pn\pi^0 \quad \text{or} \quad pn \rightarrow nn\pi^+ \quad (2)$$

In the above reactions, all the secondary particles are hadrons, namely, protons (p), neutrons (n), and pions in all their charged states (π^\pm, π^0). Pions may in turn decay according to the following processes:

$$\pi^+ \rightarrow \mu^+ \nu_\mu \quad \text{and} \quad \pi^- \rightarrow \mu^- \bar{\nu}_\mu \quad (3)$$

$$\pi^0 \rightarrow \gamma\gamma \quad (4)$$

where the μ^\pm are muons, γ are photons and $\nu_\mu, \bar{\nu}_\mu$ are respectively muonic neutrinos and their antiparticles. The mean lifetime of pions is 26 ns for π^\pm and 10^{-16} s in the case of π^0 . For this reason, charged pions may still collide with air atoms before decaying, but it is very unlikely that this happens in the case of neutral pions, which have a very short average life. Other secondary particles, like protons, neutrons, and photons, interact very frequently with the atoms of the atmosphere, which gives rise in this way to a cascade of less and less energetic secondary particles. In the end, these particles are stopped by the atmosphere or, if the energy of the primary particle is sufficiently high, they can reach the ground; see Fig. 1.

The main mechanism of energy loss⁷ of high energetic hadrons is the disintegration of the atoms of the atmosphere

⁶One should remember that the collisions of CR with the atmosphere give rise also to less relevant reactions, which produce particles like kaons, η particles, and even resonance particles (called also resonances).

⁷Here and in the following, energy means the kinetic energy of the particles.

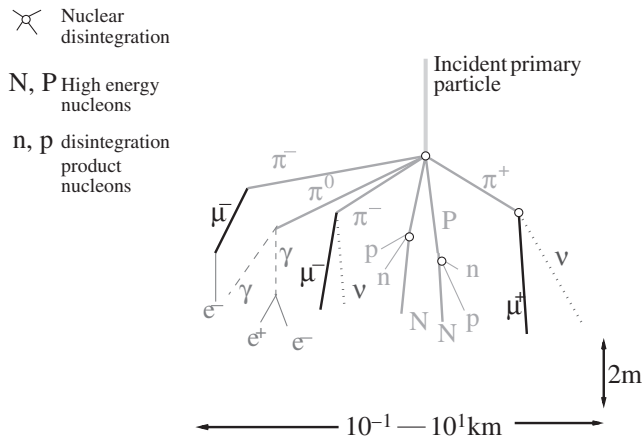

FIG. 1. This figure illustrates schematically how air showers are generated from cosmic rays. The high energetic primary particle, usually a proton, starts to interact with the molecules of the upper atmosphere. In this way, secondary particles are produced, which give rise to other particles (tertiary, quaternary, etc.) via other interactions with the atmosphere or via decay processes. The total flux of particles can be divided into an *electromagnetic component* (photons, electrons, and antielectrons or positrons), see the dark gray thin trajectories in the figure; a *muon component*, see the black thick trajectories; and finally a *nucleonic component* (mainly protons, neutrons, rarely pions), denoted in light gray.

(Sinnis *et al.*, 2003). This leads to the creation of new particles through nuclear interactions like those shown in Eqs. 1 and 2. At lower energies, dissipative processes, in which the molecules of the atmosphere are either ionized or excited, become predominant. The most relevant process of this kind with regard to heavy charged particles is the ionization of the molecules of the atmosphere. Lighter charged particles, like electrons and positrons, lose their energies not only by ionization and excitation processes but also by bremsstrahlung. This involves the radiative loss of energy of charged particles accelerating inside matter, when they are deflected by the electrostatic forces of the positive charged nuclei of the surrounding atoms. The remaining relevant particles in the cascade, photons and neutrons, are examples of indirectly ionizing radiation (neutral particles). Their interaction mechanisms will be described in Section 3.2. A more detailed account of the way in which radiation of different kinds interacts with matter can be found in the *DOE Handbook* (DOE, 1999).

The total number of secondary particles, N_{sec} , within the cascade grows rapidly, mainly sustained by the processes of bremsstrahlung and pair production (formation of an elementary particle and its antiparticle) due to electrons, positrons, and photons. Like protons and, to a lesser extent, neutrons, hadrons are easily stopped by the atmosphere, so that they increase significantly the number of particles by disintegrating the atoms of air only during the first stages of the formation of the cascade. The decays of pions, given in Eqs. 3 and 4, produce muons and photons of considerable energies. The muons are very penetrating particles and in-

teract weakly with the air. They lose a small fraction of their energy before reaching the ground by ionizing the molecules of the atmosphere. Photons with energy greater than 1.022 MeV, on the other hand, give rise to electron-positron pairs e^+e^- . In turn, electrons and positrons create other electrons by ionization or other photons due to bremsstrahlung. In this way, while the cascade propagates inside the atmosphere, the number of its electrons, positrons, and photons grows almost exponentially. The maximum number of particles inside the cascade is attained when the average energy per electron reaches the threshold $E_T \sim 80$ MeV. When the energy of electrons in air falls below that threshold, ionization starts to prevail over bremsstrahlung as the main mechanism of energy loss of electrons in air, and the process for increasing the number of particles described above ceases to be effective (Falcke and Gorham, 2002; Sinnis *et al.*, 2003).

If the energy of the primary particle is below 10^{14} eV, essentially only the penetrating muons and neutrinos are able to arrive at sea level, while the other particles in the cascade are absorbed at higher altitudes. Actually, neutrinos interact so rarely with matter that they could pass through a light year of water without undergoing any interaction. Thus, if one is concerned with the dose of ionizing radiation delivered by CR to the population, the contribution of neutrinos can simply be neglected. Muons are more dangerous for health. They have a short mean life at rest (2.2 ns); but, since they travel at very high speeds, they manage to reach the surface of Earth due to the relativistic dilatation of time. Part of these muons can still decay, which gives rise to electrons e^- or positrons e^+ , mainly according to the processes $\mu^- \rightarrow e^- + \bar{\nu}_e + \nu_\mu$ and $\mu^+ \rightarrow e^+ + \bar{\nu}_e + \nu_\mu$.

When the energy of the primary particles is above 10^{14} eV, however, the cascade of secondary particles arrives at the ground before it is stopped by the atmosphere. In that case, the cascade is referred to as an air shower; see Fig. 1. To be precise, the effects of an air shower that has been initiated by a primary particle of 10^{14} eV are relevant up to altitudes comparable to that of Mount Everest (Allan, 1971; Falcke and Gorham, 2002).

Only air showers generated by primaries of energy of about 10^{15} eV or higher are able to reach the typical altitudes of inhabited areas and arrive at sea level. The frequency of these air showers is relatively high because the total flux of primary particles with energy $E \geq 10^{15}$ eV is of about 100 particles per m^2 per year. Giant air showers produced by primaries of energies beyond 10^{20} eV are much rarer; their total flux is of 1 particle per km^2 per century (Mewaldt, 1996). More data with regard to fluxes of incoming primary particles and an explanation of how these data are measured with ground detectors can be found in Anchordoqui *et al.* (2003) and Bertou *et al.* (2000).

In the air shower, a nucleonic component, a muon component, and an electromagnetic component can be distinguished. The nucleonic component is generated by high energetic protons and neutrons, which disintegrate the atoms of the air and give rise to other protons and neutrons. The fluxes of electrons, positrons, and photons initiated by the decay of the π^0 s, together with the electrons and positrons coming from the decay of muons or from the ionization due to the hadrons, form the electromagnetic component. In early

CR research, electrons and positrons were called the soft component, while muons that result from the decay of the charged pions were called the hard component. These names were given due to the fact that muons are very penetrating; thus, they may be regarded as “hard” particles. For instance, at the energy of 1 GeV, the range⁸ of muons is $2.45 \cdot 10^5 \text{ g} \cdot \text{cm}^{-2}$. This means that in water, which has a density of $1 \text{ g} \cdot \text{cm}^{-3}$ at 4°C, muons run along an average distance of 2.45 km before being stopped. In standard rock, which has a density of $2.65 \text{ g} \cdot \text{cm}^{-3}$ (Eidelman *et al.*, 2004), this average distance reduces to about 900 m.

At sea level, an air shower has approximately the form of a pancake with a height of 1–2 meters. Its extension horizontally, defined as the area in which 90% of the total energy of the shower is contained, is given by the so-called Molière radius. In the case of an air shower initiated by a primary particle of an energy of 10^{19} eV (10 EeV), the Molière radius is about 70 meters. The real extension of the shower is much larger, and some of the muons may be detected up to a distance of a few kilometers from the core (Bertou *et al.*, 2000). Usually, the nucleonic component, which is composed of heavier particles than those of the muon and electromagnetic components, is less deflected from the direction of the incident primary particle by the interactions with the atmosphere and is thus concentrated in a narrow cone inside the air shower. The center of this cone is roughly aligned with the direction of the original primary particle. The number of secondary particles that arrive on the ground with an air shower is huge. Considering particles whose energies are greater than 200 keV, an air shower generated by a 10 EeV primary particle contains up to 10^{10} particles, mostly photons, electrons, and positrons. Electrons outnumber positrons by a ratio of 6 to 1. The maximum number of particles, *i.e.*, the so-called point of shower maximum or simply shower maximum, is attained at an altitude of 2–3 km above sea level. Many other data and diagrams that describe the propagation of air showers in the atmosphere can be found in Pierog *et al.* (2005).

When air showers approach the ground, about 85% of their energy is concentrated in the electromagnetic component. The contribution of the muon and nucleonic components is thus much less relevant. The situation changes completely if all CR are considered, not only those which have sufficient energy to give rise to an air shower. As can be seen in Fig. 2, muons are in fact responsible for about 85% of the total equivalent dose (see Subsection 3.3 for a definition of this quantity) delivered by CR to the population at sea level. As a consequence, it is the muon component, globally, that is most significant from the energetic point of view, and not the electromagnetic component. The reason for this is that primary particles with energy $E \geq 10^{15} \text{ eV}$, namely, those that can produce air showers, form a minimal fraction of the total amount of CR that arrive at Earth. For example, the

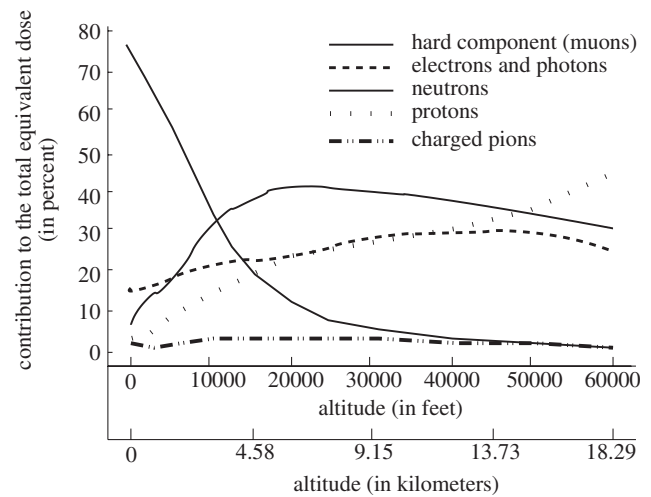

FIG. 2. Percent contribution of the various CR components to the total equivalent dose at different altitudes. This figure is based on data of O'Brien *et al.* (1996).

total flux of particles with energy $E \geq 10^{12} \text{ eV}$ (1 TeV) is of 1 particle per m^2 per second, *i.e.*, a factor of $3 \cdot 10^5$ higher than the total flux of CR with energy $E \geq 10^{15} \text{ eV}$ reported above. In other words, there is an overwhelming number of CR with energy lower than 10^{15} eV that are not able to start an air shower but may still generate energetic muons. Because they are very penetrating particles, these muons are not easily stopped by the atmosphere and penetrate to sea level, where they represent the biggest source of ionizing radiation of cosmic origin. Other particles that deliver relevant doses of ionizing radiation to the population on the surface of Earth are photons, electrons, and neutrons. The percent contributions to the total equivalent dose of the various components of CR as a function of altitude is given in Fig. 2. In that figure, which was published in 1996, the curve concerning neutrons should be taken with some skepticism because the data on neutron fluxes in the atmosphere were still sparse at that time [UNSCEAR Report Annex B (UNSCEAR, 2000a)]. Other data about energies and fluxes of particles due to CR will be given in the next section. It should be noted from Fig. 2 that protons and neutrons prevail at higher altitudes, but they are rapidly absorbed by the atmosphere so that muons become dominant at lower altitudes.

2.3. Intensities and fluxes of cosmic rays

Cosmic rays are the source of an avalanche of secondary particles that continuously strike the surface of Earth. To determine the energy and number of these particles together with their directions of arrival and their distribution in time, quantities such as the integral vertical intensity or the differential directional intensity are measured. The meaning of these quantities is explained in detail in a separate appendix at the end of this article. In this section, we present some experimental data that are useful in the characterization of the contribution of the muon, electromagnetic, and nucleonic components to the background of ionizing radiation on the ground due to CR.

⁸The range is defined as the average depth of penetration of a charged particle into a material before it loses all its kinetic energy and stops. The concept of range has meaning only in the case of charged particles whose energy is kinetic energy which is lost continuously along their paths due to ionization and bremsstrahlung processes (DOE, 1999).

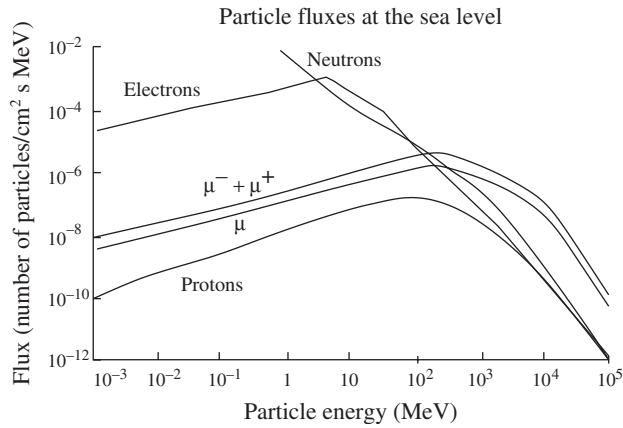

FIG. 3. Differential integrated flux (see Eq. 71 of the Appendix) of the different components of CR-related radiation at sea level. The continuation of the curve for neutrons at energies lower than 1 MeV can be found in Ziegler (1996). The figure above has been created on the basis of an analogous figure that appeared in *Cosmic Ray Muons*, material for the course Modern Physics Laboratory, held at the Carnegie Mellon University by R.A. Schumacher. The original data are taken from Ziegler (1981).

The integral vertical intensity (IVI in the Appendix; see Eq. 52) of the muon component with energy above 1 GeV at sea level is approximately $I_{ivi}^{hard}(\vartheta=0) \sim 0.70 \cdot 10^{-2} \text{ cm}^{-2} \text{ s}^{-1} \text{ sr}^{-1}$ (Eidelman *et al.*, 2004). The integral directional intensity of muons in the other directions, which are at an angle ϑ with respect to the vertical direction, has the following behavior: $I_{idi}^{hard}(\vartheta) \propto I_{ivi}^{hard}(\vartheta=0) \cos^2 \vartheta$. More complete phenomenological formulas for the angular distribution of CR intensities may be found in Eidelman *et al.* (2004), Allkofer *et al.* (1971), Allkofer (1975), and Dar (1983). As Fig. 3 shows, muons that arrive at the surface are very energetic. The most probable muon energy is 500 MeV, while the average muon energy is 4 GeV.

There is almost no protection from this source of radiation, since, as we have seen before, high energetic muons are able to penetrate thick layers of concrete and rocks.

The integral vertical intensity for electrons plus positrons with energies greater than 10, 100, and 1000 MeV is very approximately given by Eidelman *et al.* (2004):

$$I_{ivi}^{el+pos}(\vartheta=0, E_{min} > 10 \text{ MeV}) \sim 0.30 \cdot 10^{-2} \text{ cm}^{-2} \text{ s}^{-2} \text{ sr}^{-1} \quad (5)$$

$$I_{ivi}^{el+pos}(\vartheta=0, E_{min} > 100 \text{ MeV}) \sim 0.06 \cdot 10^{-2} \text{ cm}^{-2} \text{ s}^{-2} \text{ sr}^{-1} \quad (6)$$

$$I_{ivi}^{el+pos}(\vartheta=0, E_{min} > 1000 \text{ MeV}) \sim 0.02 \cdot 10^{-3} \text{ cm}^{-2} \text{ s}^{-2} \text{ sr}^{-1} \quad (7)$$

Moreover, the total flux of electrons plus positrons amounts approximately to 30% of the total particle flux that reaches the ground due to CR. According to Eidelman *et al.* (2004), the ratio of photons to electrons + positrons is approximately 1.3 if particles of energy above 1 GeV are considered. This ratio increases to 1.7 for particles whose energy is above the critical energy $E_T \sim 80 \text{ MeV}$ mentioned in the previous sec-

tion. The differential flux on the ground of the various components of radiation related to CR is displayed in Fig. 3, and it can be seen that different particles become predominant at different energies. In the lowest portion of the energy range, neutrons are predominant. At energies of around 1 MeV, the curve denoting the flux of neutrons has a bump, which is not shown in Fig. 3, due to the production of fast neutrons that arise mainly from the de-excitation of atmospheric nuclei following compound-nucleus reactions⁹ (Desilets and Zreda, 2001). Electrons become predominant in the energy range going from a few MeV to some tens of MeV. Starting from energies approximately above 200 MeV, the number of muons becomes overwhelmingly high in comparison to that of the other particles. In considering the above data, it should of course be taken into account that, at low energies, say below 10 MeV, particle fluxes are strongly dependent on many factors, including the local magnetic field, so that there are big uncertainties in their measurement up to an order of magnitude (Ziegler, 1981). Moreover, all the data presented so far in this section refer to sea-level altitude. With increasing altitudes, the contribution to the particle flux given by protons and neutrons, the nucleonic component of CR, becomes more and more relevant (see Fig. 2) and is predominant above atmospheric depths¹⁰ of approximately $500 \text{ g} \cdot \text{cm}^{-2}$.

To conclude this section, we provide some data regarding the particle flux outside the heliosphere. The total flux of CR in the Galaxy is large, about $100,000 \text{ particles} \cdot \text{m}^{-2} \cdot \text{s}^{-1}$ (Ziegler, 1998). Much lower is, for example, the integral directional flux (see Subsection A.3.1) of CR primaries with $E > 2 \cdot 10^{15} \text{ eV}$, which is about $\phi_{idf} = 75,000 \text{ particles} \cdot \text{km}^{-2} \cdot \text{sr}^{-1} \cdot \text{day}^{-1}$. This datum has been derived via a formula for the integral directional flux given in Falcke and Gorham (2002), which is based on the results of measurements and simulations of incoming cosmic ray fluxes reported in Fowler *et al.* (2001). The dependence of this flux on the direction of the incoming particles is minimal since, as mentioned before, the distribution of incoming CR particles is isotropic due to the presence of random magnetic fields in the Milky Way. Finally, the integral directional flux of particles with energies above 10^{20} eV is $\phi_{idf} = 1 \text{ particle} \cdot \text{km}^{-2} \cdot \text{sr}^{-1} \cdot \text{century}^{-1}$. With such a small flux, the investigation of CR with energy beyond the GZK limit requires detectors that cover a very large area. Perhaps with the next generation of detectors it will be possible to solve the puzzles associated with UHECR.

⁹Roughly speaking, in a compound-nucleus reaction a neutron or a proton, but also an α particle interacting with the nucleus of an atom, creates a nucleus of higher atomic number, which is metastable and decays after a short period of time. For example, a possible compound-nucleus reaction is: $p + {}^{63}\text{Cu} \rightarrow {}^{64}\text{Zn}^*$. The de-excitation of the metastable nucleus produces other neutrons and protons, e.g., ${}^{64}\text{Zn}^* \rightarrow {}^{63}\text{Zn} + n$ or ${}^{64}\text{Zn}^* \rightarrow {}^{62}\text{Cu} + n + p$. Compound-nucleus reactions become possible only if the energies of the incoming nucleons or α particles are such that the de Broglie wavelengths of these particles are comparable with the size of the hit nucleus.

¹⁰The atmospheric depth is a quantity which is often used to measure the altitude. For convenience, the diagram in Fig. 4 can be used to make the conversion from atmospheric depth in g/cm^2 to altitude in kilometers.

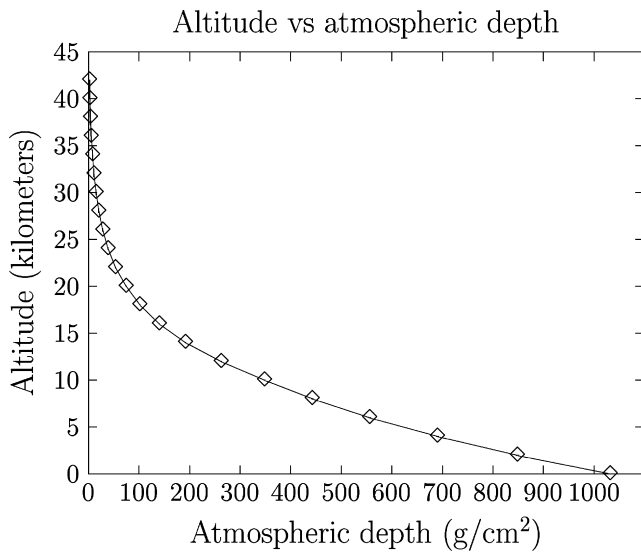

FIG. 4. Conversion diagram from atmospheric depth to altitude. The data corresponding to the dots are taken from COESA (1976).

3. A Digression on the Units Used in the Radiodosimetry of Biological Systems

3.1. The absorbed dose D and the specific energy z

The so-called absorbed dose is a quantitative measure of the energy deposited on a target by ionizing radiation. If ΔE is the energy imparted by the incoming radiation on a target of mass ΔM , the absorbed dose D is given by $D = \Delta E / \Delta M$. D is measured in grays, where 1 gray (1 Gy) means one joule of energy deposited in a mass of one kilogram of material. Clearly, the absorbed dose works very well on a piece of material which is homogeneous, for instance, a block of concrete. When the irradiated target is a biological sample, however, such as tissue that contains veins and blood, the energy deposition will be strongly inhomogeneous, because tissue, blood, and veins have different densities and chemical compositions. In a word, their ability to absorb radiation is different. In this case, the measured value of ΔE is an average of the energy absorbed by the different components present in the sample. There is nothing incorrect with the absorbed dose if measuring the average energy absorbed by a complicated biological system, like an organ or the whole body of a person. However, when dealing with very low doses, such as those delivered by cosmic radiation, it would be advantageous to specify precisely what the target of the radiation is. In the above example of a biological sample with tissues, blood, and veins, only one vein, for instance, could be selected for measurement of the energy deposited in it. Actually, for radiobiological purposes, much smaller targets are needed, such as cells, nuclei of cells, or even smaller structures within the cell. The concept of absorbed dose plus this procedure of selecting the target of the irradiation give rise to a new quantity, the specific energy z . It can be expressed as $z = \epsilon / m$, where ϵ is the energy imparted to a piece of matter of mass m inside the defined target (Bréchnignac *et al.*, 2002). The unit of z is again the gray.

Other quantities have been considered in order to deal with the energy delivered by radiation, such as the exposure

X and the kinetic energy released in unit of mass (KERMA). The exposure measures the charge ΔQ of ions created by photons (gamma or X-rays) in a mass ΔM of air, *i.e.*, $X = \Delta Q / \Delta M$. The unit of exposure is the roentgen. One roentgen refers to the dose of photons needed to produce, in a kilogram of dry air, $2.58 \cdot 10^{-4}$ coulombs or, in other words, $1R = 2.58 \cdot 10^{-4} \frac{C}{kg}$. The roentgen is easy to measure directly but may be used to describe only the effects of photons in air.

The KERMA K has been considered to estimate quantitatively the effects of uncharged particles like photons and neutrons. In medical physics literature, these particles are often referred to as indirectly ionizing radiation. The KERMA is defined as $K = \frac{\Delta E}{\Delta M}$, where ΔE is the kinetic energy of all the charged particles that are generated by the interaction of the uncharged particles with a material of mass ΔM . The unit of KERMA is the gray. The KERMA is not measurable directly, as is the exposure or the absorbed dose, but may be related to the absorbed dose. Both exposure and KERMA will not play any relevant role in the following discussion.

3.2. A microscopic characterization of the damage induced by different kinds of radiation: stopping power and linear energy transfer

The absorbed dose and the related specific energy can be defined for every type of radiation, which is not the case for exposure and KERMA, but they are not suitable to describe the biological effects of radiation. Of course, the bigger the absorbed energy or the specific energy, the bigger will be the damage done by radiation inside a target. Yet these quantities alone are not sufficient to estimate the level of damage, because it must also be taken into account that what is commonly called radiation consists actually of fluxes of particles of various types. X-rays and gamma rays are examples of electromagnetic radiation. They consist of photons, which are massless particles. All other kinds of ionizing radiation that are relevant to our macroscopic world, such as alpha and beta rays, consist instead of massive particles, like electrons, protons, neutrons, heavier nuclei. The energy delivered by radiation to the target is stored in the kinetic energy $E = \epsilon - mc^2$ of each particle composing it, where ϵ is the total energy, including the rest energy in the relativistic case.¹¹ If two identical samples receive the same dose of radiation, except one sample is irradiated with ^{60}Co photons while the other is irradiated using alpha particles whose average energy is 5 MeV, the effects of the irradiation will not necessarily be the same, even if the absorbed dose was the

¹¹For a photon, which has vanishing mass $m=0$, this statement should be somewhat refined. In this case the relation $\epsilon^2 - \mathbf{p}^2 c^2 = m^2 c^4$ reduces to $\epsilon = E = pc$, where $p = |\mathbf{p}|$. On the other side, in the wave function of a free photon, the moment p is related to the de Broglie wavelength λ by the formula $p = h/\lambda$, h being the Planck constant. Finally, one should remember that the speed of the photon is c , so that the wavelength λ and the frequency f of the wave function must obey the identity $\lambda f = c$. Putting all these relations together, one finds $E = hf$, which is the well-known value of the energy of a photon whose probability function is a plane wave with frequency f .

same for both samples. This is because photons and alpha particles interact with matter in different ways. The situation is further complicated by the fact that the interaction mechanisms depend on the kinetic energy carried by the particles. These mechanisms will be briefly described below. For a full account of them, see for example UNSCEAR Report, Annex G (UNSCEAR, 2000c).

Photons lose their energy inside materials according to three different mechanisms: photoelectric effect, which plays a relevant role at low energies, up to a few tenths of a MeV; Compton scattering; and pair production. Pair production $\gamma \rightarrow e^- + e^+$ starts with a threshold energy of about 1.02 MeV and replaces Compton scattering as the dominant mechanism of energy loss of photons at energies of 5 MeV or more. The energy of neutrons is instead absorbed by interactions with the nuclei of the atoms. There are many possible interaction mechanisms, which are in turn strongly dependent on the energy of the neutron. Their detailed discussion is beyond the scope of this work and will not be presented here. Heavy charged particles like protons and alpha particles lose their energy mainly by ionization or excitation of the atoms of the target, while the trajectories of light charged particles like electrons undergo relevant losses of energy also by bremsstrahlung. Ionization and excitation are due to collisions between the incoming particle and the electrons of the atoms of the target. Apart from collisional processes, there are also radiative processes, in which particles lose energy by production of photons, as for instance in the case of bremsstrahlung. Since neutrons do not interact with the electrons of the atoms, they do not leave ionization tracks¹², as do photons and charged particles, and their detection is more difficult. This is why available data on the contribution of neutrons to the natural background radiation of cosmic origin are still sparse.

Considering the wealth of possible mechanisms by which particles interact with matter, it is reasonable to expect that the nature of the damage done by radiation to a biological system will depend both on the particle composition of the delivered radiation and the kinetic energy of these particles. To return to the example of the alpha particle and of the ⁶⁰Co photon mentioned above, it turns out that a single track of an alpha particle of 5 MeV delivers to the nucleus of a cell¹³ a specific energy of 370 mGy. A single track of a ⁶⁰Co photon, however, delivers to the same nucleus only 0.1 mGy [UNSCEAR Report, Annex G (UNSCEAR, 2000c)]. This implies that, to equate the dose due to the interaction of a single alpha particle, several photons should hit the nucleus of the cell and, thus, produce several tracks. As a result, the damage done to the cell by the alpha particle is likely to be heavy and localized in a narrow region along the trajectory of the particle, while the photons will cause regions of lesser damage in different locations of the nucleus.

From the above discussion, it is clear that absorbed dose and specific energy give a rough estimate of damage due to radiation on living organisms, because they consider just the average deposited energy on a target. Detailed study of

the mechanisms by which particle energy is lost inside materials will allow for more insight into resultant damage. Our understanding of these mechanisms at the microscopic scale, *i.e.*, at the level of atoms, is fairly good. For example, we know that charged particles are gradually stopped in matter by collisional or radiative processes, which occur with probabilities dictated by the corresponding interaction cross sections. Such cross sections may be computed via Monte Carlo simulations with a high degree of precision, and for certain energy regimes there are analytical expressions. With use of this knowledge, it is possible to derive the stopping power $S(E)$, a quantity which is dependent on the type and energy E of the interacting particle and on the properties of the material through which this particle passes:

$$S(E) = \frac{\Delta E}{\Delta x} = - \left(\frac{\Delta E}{\Delta x} \right)_{coll} - \left(\frac{\Delta E}{\Delta x} \right)_{rad} \quad (8)$$

In the above formula, ΔE denotes the average energy loss of a charged particle when it travels for a small distance Δx inside a piece of material. Units commonly used for the stopping power are keV/microns or MeV/cm. Very often, rather than the stopping power, the mass stopping power is used, which is defined by the ratio $S'(E) = (1/\rho) S(E)$, where ρ is the density of the material. $S'(E)$ is measured in $\text{MeV} \cdot \text{cm}^2 \text{g}^{-1}$. As can be seen in Eq. 8, the stopping power depends on both contributions from collisional processes $(\Delta E/\Delta x)_{coll}$ and radiative processes $(\Delta E/\Delta x)_{rad}$. The latter processes, as mentioned earlier, produce photons, which are penetrating particles and, thus, may be able to escape from the irradiated sample without depositing their energy in it. As a consequence, to estimate the damage done by radiation, a better quantity than the stopping power is the linear energy transfer or LET:

$$LET = - \left(\frac{\Delta E}{\Delta x} \right)_{coll} \quad (9)$$

which takes into account only collisional processes. With the previous example of the alpha particle of 5 MeV and the ⁶⁰Co photon in mind, it is clear why there are such large differences in the energy deposited by a single track of these particles in a cell nucleus. The main reason is that the cross section that gives the probability that an alpha particle removes one electron of an atom is much bigger than the analogous cross section of a photon. Indeed, an alpha particle of 5 MeV produces several thousand ionized atoms inside the nucleus, while the photon produces just a few tens [UNSCEAR Report, Annex F (UNSCEAR, 2000b)]. This, of course, results in a higher value of the LET for the alpha particle with respect to the photon. Indeed, alpha particles are an example of high-LET radiation, while photons are an example of low-LET radiation, together with electrons, positrons, and muons.

3.3. Relative biological effectiveness and equivalent dose

Linear energy transfer provides to some extent a good estimation of the effects produced in biological systems by

¹²An ionization track or simply a track is the trail of ion pairs produced by the passage of ionizing radiation inside a material.

¹³Here it is supposed that the nucleus has approximately the form of a sphere with a diameter of $8 \mu\text{m}$.

radiation that consists of charged particles. In similar ways, it is possible to study the effects produced by neutrons, photons, or other uncharged particles. Unfortunately, it is not easy to relate microscopic damage such as the ionization of some atoms of DNA to such complex effects as somatic mutations. For example, cells have their own mechanisms by which to repair damage due to radiation. When a high dose of radiation is delivered to a cell, the cell is damaged by several particle tracks, and the various damaged parts of the cell can interact together during the repair. In this situation, it is not possible to determine the final result after the repairing action. Moreover, the information contained in DNA has some redundancy, so that local changes in the DNA sequence may not result in observable consequences on a cell. In other words, biological systems are very complicated and, to date, no one has been able to predict the response of a living organism to irradiation from the microscopic point of view. Even from a larger perspective, going, say, from the atomic to the molecular level, the ability to assess damage to the double helix of DNA by ionizing radiation is little improved. The different kinds of damage to DNA, the probabilities with which they occur, and the mechanisms by which they are repaired are all fairly well known [UNSCEAR Report, Annex F (UNSCEAR, 2000b)]; but in practice it is impossible to apply this knowledge in order to predict the probability of a long-term effect, such as the occurrence of cancer or of a somatic mutation. Since theory fails to determine the effects of different kinds of radiation on biological systems, one has to resort to experimental measurements. A possible strategy would be to compare the amount of damage produced by one type of radiation to that produced by a reference type of radiation. To this aim, it would be best to choose a given biological effect and a given reference radiation. Possible biological effects can be, for instance, the killing of 50% of cells in a sample, tumor induction in a biological tissue, or the induction of chromosome aberrations or micronuclei in some percentage of cells of a certain type in a culture. Usually, reference radiations are X-rays or gamma rays of a given energy or energy spectrum. To compare, for example, the strength of radiation Z (where Z can be electrons, photons, neutrons, etc., with kinetic energy E_Z) with that of a reference radiation given by 250 kVp X-rays¹⁴, one could measure the absorbed dose $D_{250\text{kVp}}$ of the reference radiation, which would be necessary to produce the selected biological effect and the absorbed dose D_Z of radiation Z needed to obtain the same effect. The ratio of these two values is called the relative biological effectiveness or RBE (ICRP, 1991b):

$$RBE_Z = \frac{D_{250\text{kVp}}}{D_Z} \quad (10)$$

The value of RBE_Z gives the *quality* of the Z radiation, *i.e.*, the capability of that radiation to produce some biological effect

¹⁴For historical reasons 250 kVp X-rays have been taken as reference radiation. This refers to the radiation generated by an X-ray tube in which electrons are accelerated to the energy of 250 kilovolts. The resulting X-rays have a wide energy spectrum. The upper limit of the photon energy is of course 250 keV.

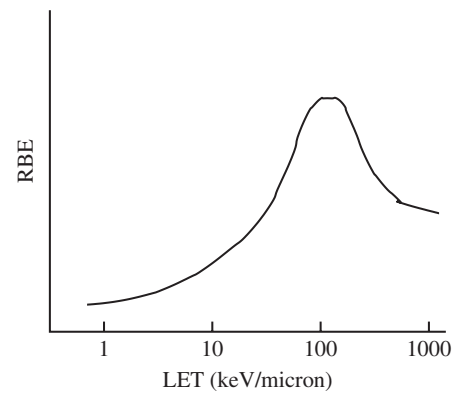

FIG. 5. Qualitative dependence of RBE on LET.

compared with the capability of the reference radiation to produce the same effect. The value of RBE depends not only on the kind and energy of the Z radiation but also on the chosen biological effect B_{eff} and on other parameters, such as the dose rate $\dot{D} \equiv \frac{dD}{dt}$, the kind of irradiated cells t_{cell} , and so on. In other words, $RBE_Z = RBE_Z(E_Z, B_{\text{eff}}, \dot{D}, t_{\text{cell}}, \dots)$. The qualitative relationship between LET and RBE, which has been shown by measuring the RBE in the case of many possible biological effects, including cell killing, mutations, and chromosomal aberrations (IAEA, 2001), is given in Fig. 5. We note that the RBE of radiation increases with LET as expected up to a maximum, which occurs when LET is approximately equal to 100 keV/micron, and then starts to decrease. The reasons for this decrease are explained in *IAEA Report* (IAEA, 2001).

In applications of human radioprotection, the concept of RBE has been simplified and replaced by that of *equivalent dose* $H_{Z,T}$ to an organ or a tissue T . What is the idea behind the equivalent dose? First of all, we note that Eq. 10 may be rewritten as follows:

$$D_{250\text{kVp}} = RBE_Z D_Z \quad (11)$$

In Eq. 11, the absorbed dose $D_{250\text{kVp}}$ may be interpreted as the dose of reference radiation that is the equivalent, *i.e.*, it gives the same effect of an absorbed dose D_Z of Z radiation. The RBE is the proportionality factor between the two doses. As already mentioned, the RBE depends on many parameters, but for medical purposes the most important are the type of radiation Z and the tissue T that has to be irradiated. Thus, we may put $RBE_Z = RBE(Z, T)$. Following this new interpretation of Eq. 10, it will be advantageous to change the symbols appearing in it, writing $H_{Z,T} = D_{250\text{kVp}}$ and $Q(Z, T) = RBE(Z, T)$, so that Eq. 11 becomes

$$H_{Z,T} = Q(Z, T) D_Z \quad (12)$$

It should be kept in mind that D_Z also depends on T . When the Z radiation coincides with the reference radiation, *i.e.*, $Z = 250 \text{ kVp}$, we have of course $Q(250 \text{ kVp}, T) = 1$. The quantity $H_{Z,T}$ will be identified later with the equivalent dose. At this stage, however, $H_{Z,T}$ still coincides with the dose of reference radiation $D_{250\text{kVp}}$, and the factor $Q(Z, T)$ coincides with the RBE. Thus, as explained above, both $H_{Z,T}$ and $Q(Z, T)$ are

dependent on several parameters, a fact that makes it difficult to use directly the quantity $H_{Z,T}$ in practical applications.

To avoid this complication, the International Commission on Radiological Protection (ICRP) has proposed to approximate the RBE, or equivalently the quantity $Q(Z,T)$, as follows:

$$Q(Z, T) \sim w_T w_Z \tag{13}$$

The two factors w_T and w_Z are called *tissue weighting factor* and *radiation weighting factor*, respectively. Sometimes, w_Z is also called the *quality factor*. While the RBE is a continuous function of the energy of the radiation and of LET, the factor w_T is just a weighting factor such that $\sum_T w_T = 1$; see

Table 1 (ICRP, 1991a; Bréchnignac *et al.*, 2002). The quality factor w_Z is instead a discrete function of the energy E_Z , see Table 2 (ICRP 1991a; Bréchnignac *et al.*, 2002), and of LET, see Table 3 (Morera, BSEN-625). Moreover, the biological effect taken into account in order to estimate w_T and w_Z is essentially the induction of cancer in humans (Bréchnignac *et al.*, 2002). After the approximation (Eq. 13), Eq. 12 is replaced by the simplified relation:

$$H_{Z,T} = w_T w_Z D_Z \tag{14}$$

The unit of the equivalent dose $H_{Z,T}$ is the sievert (Sv). Formally, since w_Z is a dimensionless parameter, 1 sievert means one joule per kilogram of mass, exactly like the gray.

Finally, we define the *effective dose* and the *effective dose rate* (EDR), two quantities which will be used in the next subsection. The effective dose H_Z is obtained after averaging the equivalent dose $H_{Z,T}$ over T :

$$H_Z = \sum_T H_{Z,T} = \sum_T w_T w_Z D_Z \tag{15}$$

The effective dose rate \dot{H}_Z is the effective dose delivered in the unit of time, *i.e.*,

$$\dot{H}_Z = \frac{dH_Z}{dt} \tag{16}$$

TABLE 1. VALUES OF THE TISSUE WEIGHTING FACTORS w_T FOR VARIOUS ORGANS T

Tissue or organ T	w_T
Gonads	0.20
Bone marrow (red)	0.12
Colon	0.12
Lung	0.12
Stomach	0.12
Bladder	0.05
Breast	0.05
Liver	0.05
Esophagus	0.05
Thyroid	0.05
Skin	0.01
Bone surface	0.01
Remainder	0.05

The data of this table are taken from Bréchnignac *et al.* (2002) and ICRP (1991a).

TABLE 2. VALUES OF THE QUALITY FACTOR w_Z

Radiation type and energy range	Radiation quality factor w_Z
Photons of all energy	1
Electrons and muons of all energies	1
Neutrons of energy:*	5
<10 keV	5
>10 keV to 100 keV	10
>100 keV to 2 MeV	20
>2 MeV to 20 MeV	10
>20 MeV	5
Protons, other than recoil protons, of energy >2 MeV	5
Alpha particles, heavier nuclei, fission fragments	20

The data of this table are taken from Bréchnignac *et al.* (2002) and ICRP (1991a).

*The prescriptions for assigning the values of the quality factors for different kinds of radiation are steadily updated. A more modern prescription for neutrons of energy E given in MeV is the following: $w_{neutrons,E} = 5 + 17 \exp[-(\log 2E)^2/6]$.

3.4. Dose of ionizing radiation from cosmic rays in present times

At present,¹⁵ the total EDR (see Eq. 16) delivered by CR to the human population varies from a minimum of about $300 \mu\text{Sv}\cdot\text{year}^{-1}$ to a maximum of $2000 \mu\text{Sv}\cdot\text{year}^{-1}$. This wide range depends on many factors, the most important one of which is the altitude. At sea level, the value usually given for the EDR is $270 \mu\text{Sv}\cdot\text{year}^{-1}$, or equivalently $31 \text{nSv}\cdot\text{h}^{-1}$. However, this value does not take into account the contribution of neutrons. It should also be kept in mind that this estimate is the result of a population-weighting average. In fact, even if the altitude is fixed at sea level, the EDR still changes with latitude within a range of variation of approximately 100%. The reason for this variation is the geomagnetic field, which acts like a shield against CR. At the equator, the strength of this shield is at its maximum, and all CR with energy smaller than 15 GeV cannot penetrate the upper atmosphere. When one moves away from the equator, with increasing (or decreasing) latitudes, the shielding effect of the geomagnetic field becomes weaker and weaker until it attains its minimum at a latitude of about 50° (or -50° going south from the equator). Above the 50^{th} parallel (or below the -50^{th} parallel), the intensity of CR is no longer dependent on the latitude and becomes constant. The details of the dependence of CR on the geomagnetic field are explained in Shea and Smart (2000).

Strictly speaking, $270 \mu\text{Sv}\cdot\text{year}^{-1}$ is the dose rate received by the population living at a latitude near the 30° parallel. As it happens, this is the average latitude at which people are living as a consequence of the current distribution of human population. Also, the above value of EDR takes into account only the contributions of muons and of the electromagnetic component of CR. The nucleonic component, which at sea

¹⁵The data concerning the present levels of radiation coming from CR are taken from the United Nations Report of the year 2000 [UNSCEAR Report, Annex B (UNSCEAR, 2000a)].

TABLE 3. DEPENDENCE OF w_z ON LET

LET (MeV/cm)	w_z
<3.5	1
3.5–7.0	1–2
7.0–23	2–5
23–53	5–10
53–175	10–20
Gamma rays, X-rays, electrons,* positrons of any LET	1

The data of this table are taken from Morera (BSEN-625).

*It should be noted that there are some exceptions in the assignment of the quality factor to the different kinds of radiation that are not displayed in the table. For instance low-energy electrons, like the Auger electrons, which have an energy range from 10 eV to 10 keV, are high-LET radiation and have $RBE \geq 10$. For this reason, Auger electrons have a quality factor which is bigger than that assigned in Table 3 to electrons, which is the unity.

level essentially consists of neutrons, gives to the average EDR an additional contribution of $48 \mu\text{Sv}\cdot\text{year}^{-1}$ or, equivalently, $5.5 \text{ nSv}\cdot\text{h}^{-1}$. As mentioned above, the data concerning neutrons should be taken with some care, since up to the time the UNSCEAR Report, Annex B (UNSCEAR, 2000a) was released, the available data on neutron fluxes were sparse. If one considers also the different altitudes at which the human population lives, the population-weighted EDR is of $380 \mu\text{Sv}\cdot\text{year}^{-1}$, which corresponds to an average habitant of planet Earth who lives near the 30th parallel and at an altitude of 900 meters above the sea level.

4. Relevance of Cosmic Rays in Astrobiology: Cosmic Rays as a Source of Mutation

Cosmic radiation arriving at Earth is an important component of the natural background of ionizing radiation. This kind of radiation is able to induce mutations in DNA, which is the repository of the genetic code of all organisms on Earth. It is thus clear that CR likely played, and still play, a relevant role in the evolution of life, along with other sources of mutagenesis, such as mutagenic compounds, background radiation of terrestrial origin, and ultraviolet radiation from the Sun. While the energy input of CR is tiny, about one-billionth of solar irradiance, CR are the dominant source of penetrating ionizing radiation. They produce by interaction with the atoms of the atmosphere light radioisotopes such as ^{14}C and ^{10}Be (Carslaw *et al.*, 2002). As was seen in Subsection 3.4, the data show that the effective dose of ionizing radiation due to CR is relatively low, for instance, with respect to the occupational dose limit in the United States, which amounts to $50,000 \mu\text{Sv}$. However, those data reflect the delivered effective dose, a quantity that is significant only in part for astrobiological purposes.

As already mentioned, the effective dose is a quantity that has only to do with the human population and takes into consideration as a biological effect the induction of cancer. However, during the eras relevant to astrobiology, for example, the Archeozoic geological era when life began, the organisms of that time were certainly different from the human species. It is very likely that organisms of

early Earth possessed DNA that was unstable and could easily mutate under external agents, more so, perhaps, than the DNA of present-day bacteria. According to a suggestion by Trifonov, which is supported by physical and biological evidence, ancient proteins consisted of 25–35 amino acid residues. These proteins were synthesized by DNA pieces containing around 600 base pairs (Berezovsky and Trifonov, 2001).¹⁶ It is difficult to evaluate or even imagine the effects that ionizing radiation could have had on such ancestral organisms. The RBE varies in fact with many parameters. On one side, there are physical parameters, like type of radiation, dose, dose rate, and fractionation of dose. On the other side, there are biological parameters, like type of biological effect considered and type of organism. Physical parameters are the easiest to reproduce in laboratories, though we do not know exactly the physical conditions present on the surface of Earth when life started at about 3.85 Ga (Gilmour and Sephton, 2004). In particular, to establish how high a dose was delivered by cosmic radiation in a given past era, it is necessary to know what the chemical composition of the primitive atmosphere was at that time. Moreover, a relatively nearby galactic event that was very violent could have influenced, at some stage, the successive evolution of life by increasing considerably the dose of ionizing radiation on Earth. In the next section, we estimate how close to our planet such an event would have to be to produce relevant effects.

It is a far more complicated endeavor to reproduce the biological parameters in the absence of any clue as to what organisms looked like in the first two billion years of the history of life.¹⁷ The best approximation of the first organisms is probably provided by the simplest prokaryotic cells living at present times. One of the advantages of these cells is that they are able to multiply themselves very rapidly. Within a period of 9 months, it is possible to obtain 540 generations of a bacterium like *Escherichia coli*. Indeed, *E. coli* has already been used in order to study the evolution of life-forms. For example, conclusive proof that Darwin, not Lamarck, was right was provided in 1943 by an experiment with *E. coli* (Luria and Delbrück, 1943). More recently, experiments with *E. coli*, the aim of which is to study the influence of cosmic radiation on evolution, have been conducted inside the Laboratory of Gran Sasso in Italy (Satta *et al.*, 2002).

When exploiting prokaryotic cells or any other kind of organism with the purpose of tracing back possible long-

¹⁶We would like to mention at this point the role that the micro RNA, in short miRNA, may have played in evolution. Micro RNA is a single-stranded RNA molecule containing about 21–23 nucleotides that regulates the action of genes, for instance blocking the production of certain proteins. First discovered in 1993 in a worm called *Caenorhabditis elegans* (Lee *et al.*, 1993), only recently (Ruvkun, 2001) miRNA has been discovered in several other organisms, including humans and plants. Moreover, genes have been found in bacteria which are very similar to miRNA. This is an important fact from the astrobiological point of view if one takes into account that bacteria represent good approximations of the ancient living form; see comment below.

¹⁷Up to two billion years ago, even if there are no preserved fossils, it is possible to get some idea of the DNA of primitive organisms thanks to powerful algorithms of genetic reconstruction.

term effects due to cosmic radiation, however, it must be kept in mind that the radiosensitivity of these organisms varies strongly from one species to the other. Even eukaryotic cells, which are very close to each other from a genetic point of view, show different responses to ionizing radiation and thus give different values of RBE. In the case of prokaryotic cells, the situation is much more extreme. One archaean, such as *Deinococcus radiodurans*, may withstand a dose of 5000 Gy without losing its functionality, while for a bacterium like *E. coli* a dose of 60 Gy is fatal. In other words, concepts such as effective dose and EDR, which are based on the probability that ionizing radiation induces cancer or other somatic mutations in the human population, cannot be applied to study the effects of radiation on organisms like prokaryotic cells and thus become useless for astrobiological purposes. It would be best to concentrate on RBE measurements based on possible biological effects that exhibit universal features of the organisms' response to radiation, because it is most likely that some of these features may have been shaped by the very long-term effects of cosmic radiation. CR have, in fact, created an almost uniform background of ionizing radiation at the surface of Earth. This background is present everywhere, even underground and underwater, because of the high penetrating power of muons. It is thus reasonable to assume that present life-forms on Earth have acquired some adaptive response to this source of radiation. Universal features to be investigated are, for example, an acquired resistance against low-LET radiation such as muons with respect to a high-LET type of radiation such as protons. Indeed, we have seen that most of the effective dose due to CR arrives at the surface of Earth in the form of muons, while protons are stopped by the atmosphere at higher altitudes. Moreover, before the appearance of cyanobacteria, the percentage of oxygen in the atmosphere was considerably lower than at present. Therefore, it may well be that some organisms developed a particular sensibility to types of radiation that are easily stopped by oxygen molecules.¹⁸ It would also be interesting to measure how the RBE relative to different biological effects varies with respect to the LET in the case of prokaryotic cells. Similar measurements performed on mammalian cells show, in fact, that for many biological effects the curves that give the dependence of the RBE on LET are always of the qualitative form given in Fig. 5. It is thus licit to suspect that there should be some universality behind this regularity.

5. How Distant Must a Cosmic Event Be to Produce a Visible Effect on Earth? An Example Calculation

When studying the possible effects of CR on life on Earth, it is important to keep in mind that the flux of CR is not constant in time. For example, since CR consist of charged

particles, their flux is influenced by the magnetic fields in the heliosphere. These magnetic fields change in connection with solar activity, as mentioned before. This and other variations may be observed by measuring the concentration of ¹⁰Be in the ice layers of Greenland and Antarctica. ¹⁰Be is a radio-nuclide that is produced by the interaction of CR with oxygen and nitrogen atoms and then, after precipitation on aerosols, is stored for a very long time in the natural archive of polar ice (Usoskin *et al.*, 2002).

What about changes in the levels of CR radiation due to far cosmic events? It is very difficult to estimate the effects of a distant source of CR on Earth by taking into account all possible parameters, including the modulation by the magnetic fields inside the heliosphere or the interaction of the primary particles with the terrestrial atmosphere. For this reason, we consider here estimation of only the increase of energy density in space near Earth due to a source of CR that becomes active at some time. Naively, if that density increases by a factor *N*, it would be expected that the effects of the CR radiation on the surface of Earth would increase by the same factor. At present, the total energy density¹⁹ of CR in our galaxy outside the heliosphere is about 1 MeV/m³. This datum (Ziegler, 1998) takes into account only GCR and not charged particles emitted by the Sun. According to Wolfendale (1979), the energy density above a particle energy of 1 GeV has been estimated to be about 0.5 MeV/m³. We will thus assume that the energy density of CR near Earth is approximately of the order of 1 MeV/m³, *i.e.*,

$$E_D^{CR} \sim 1 \text{ MeV/m}^3 \tag{17}$$

At this point, we consider a distant source *p* that generates a flux of cosmic rays arriving at Earth. We would like to evaluate the distance *R* from Earth at which *p* should be located in order to produce relevant effects on our planet. We denote with the symbol *L_p* the luminosity of the distant source, which should be pointlike. Here, the luminosity *L_p* represents the total energy emitted by the source in the form of CR (*i.e.*, in the form of charged particles) in the unit of time. Energies released in other forms—neutrinos, gamma rays, and so on—will be ignored. Also, light charged particles, like electrons, are neglected here, because their trajectories are easily bent by the galactic magnetic fields; for this reason, they quickly lose their energy due to bremsstrahlung. Moreover, again due to bremsstrahlung, they cannot be accelerated so efficiently by the source, as protons or heavier nuclei are. In supernova remnants (discussed below), they attain at most energies of the order of 1 TeV. As units for *L_p*, we choose [*L_p*] = $\frac{\text{erg}}{\text{sec}}$. If the distance *R* from source to Earth is measured in meters, (*[R]* = m), the energy arriving at Earth in the form of CR due to the emission of the charged particles from the pointlike source *p* is given by the relationship:

$$F_p = \frac{L_p}{4\pi R^2} \quad [F_p] = \frac{\text{erg}}{\text{m}^2 \text{ sec}} \tag{18}$$

which determines the flux *F_p* of kinetic energy carried by charged particles emitted by the source at a distance *R*. The energy flux is defined in the Appendix; see Eq. 73. Of course, in writing Eq. 18, we assume that the source is emitting the

¹⁸As a nice coincidence with this hypothesis, it is worth mentioning that oxygenated cells are more radiosensitive than anoxic (*i.e.*, without oxygen) cells. The investigations of the sensibility of cells in the sense described here have been performed using UV radiation (Arrage *et al.*, 1993; Cockell and Knowland, 1999). This type of radiation is absorbed by the oxygen, which composes the ozone layer in the upper part of the atmosphere.

¹⁹The energy density is defined in the Appendix, Eq. 62.

energy uniformly in all directions. Not all sources of CR satisfy this condition, but supernova remnants (SNRs), for example, do. In a supernova explosion, an enormous amount of material is ejected into space. This expanding material interacts with the surrounding gas and produces strong shocks, which are able to accelerate protons up to energies of 10^{15} eV. SNRs have sizes of the order of a parsec, but still they can be considered as pointlike if the distance from Earth is big enough.

At this point, we compute the contribution to the energy density of CR associated with the flux of energy F_p . We denote this energy density from the source p with the symbol E_D^p . Since the distance R is supposed to be large, the incoming rays (particle trajectories) that give rise to the energy flux arrive, in practice, on Earth from a unique direction and are almost parallel. Of course, if R is too big, the random component of the galactic magnetic field will deviate the beam significantly. Moreover, we are interested in very energetic particles that cannot be deflected by the magnetic field of the Solar System, say, with energies above 1 GeV. Thus, these particles will be moving so fast that we may approximate their speed with the speed of light c . As a consequence, the energy passing during a short time interval Δt through a small surface of area ΔS perpendicular to the trajectories of the particles will be:

$$\Delta E = c \Delta t \Delta S E_D^p \quad (19)$$

By putting $c \Delta t \Delta S = \Delta V$, the expression of the energy density E_D^p may be written as follows:

$$E_D^p = \frac{\Delta E}{\Delta V} \quad (20)$$

On the other side, the same amount of energy ΔE can be written as a function of the energy flux F_p :

$$\Delta E = \Delta t \Delta S F_p \quad (21)$$

i.e.,

$$F_p = \frac{\Delta E}{\Delta S \Delta t} = c \frac{\Delta E}{\Delta V} \quad (22)$$

Comparing Eqs. 19 and 21, we obtain the identity

$$E_D^p = \frac{F_p}{c} \quad (23)$$

With the expression of F_p given in Eq. 18, it turns out that

$$E_D^p = \frac{L_p}{4\pi c R^2} \quad (24)$$

The above equation provides the desired dependence of the contribution E_D^p to the energy density outside the heliosphere due to the presence of the distant source p on the relevant physical parameters, namely, the luminosity L_p , and the distance R of the source from Earth. Now we impose the condition that the value of E_D^p of CR coming from p is N times the value of the energy density at present times, *i.e.*,

$$E_D^p = N \cdot E_D^{\text{CR}} \quad (25)$$

Substituting the above expression of E_D^p in Eq. 24 and solving this last equation with respect to R , we obtain the distance at

which the source should be located in order to give an increase of the energy density in the vicinity of Earth of a factor N :

$$R = \frac{1}{\sqrt{N}} \sqrt{\frac{L_p}{4\pi c E_D^{\text{CR}}}} \quad (26)$$

What then is the order of magnitude of R in the case of a SNR? A reasonable estimate of the luminosity L_{SNR} for a SNR can be derived from the data of Strong and Moskalenko (2001), who assumed that there are about three supernova explosions in our galaxy every 100 years and SNRs emit CR for a time t_{CR} of the order $10^4 \leq t_{\text{CR}} \leq 10^5$ years. Thus, the number N_{SNR} of SNRs that are active emitters of CR in our galaxy is about $N_{\text{SNR}} \sim \frac{3}{100} \cdot t_{\text{CR}}$. Using the above estimates of t_{CR} , we obtain $3 \cdot 10^2 \leq N_{\text{SNR}} \leq 3 \cdot 10^3$. On the other side, we know from Strong and Moskalenko (2001) that the total CR energy emission from all SNRs in our galaxy is $L_{\text{MW}}(\text{SNR}) \sim 2 \cdot 10^{41} \frac{\text{erg}}{\text{s}}$. As a consequence, the luminosity of a single SNR will be in the average $L_{\text{SNR}} = L_{\text{MW}}(\text{SNR}) / N_{\text{SNR}}$. From the previous considerations, it turns out that $10^{38} \leq L_{\text{SNR}} \leq 10^{39} \frac{\text{erg}}{\text{s}}$. Here, we suppose that the value of L_{SNR} coincides with the upper limit of the above range:

$$L_{\text{SNR}} \sim 10^{39} \frac{\text{erg}}{\text{s}} \quad (27)$$

Besides the source luminosity, the other ingredient appearing in Eq. 26 is the energy density E_D^{CR} , which is given by Eq. 17. Remembering also that

$$1 \text{ MeV} = 1.602 \cdot 10^{-6} \text{ erg} \quad (28)$$

$$c = 3 \cdot 10^8 \frac{\text{m}}{\text{s}} \quad (29)$$

$$1 \text{ m} \sim \frac{1}{3} \cdot 10^{-16} \text{ parsec} \quad (30)$$

in the case of a SNR we obtain from Eq. 26:

$$R \sim \frac{1}{\sqrt{N}} \cdot 14 \text{ parsec} \quad (31)$$

The above equations imply that, to give some relevant effects on Earth, the source of CR must be relatively close to our planet, with distances of the order of a few tens of parsecs or even less, depending on the factor N .

This value of R is small in comparison with the cosmic scale of distances. Thus, our calculation puts some limits on the effectiveness of CR from a SNR to make dramatic changes on Earth. However, this does not mean that a cosmic event cannot endanger the existence of life on Earth. As indicated above, the flux of particles F_p from the source p reaching Earth has been calculated in Eq. 18 under the hypothesis that the emission of CR is isotropic. This is not the case for events that send very collimated jets of particles such as NS-NS mergers.²⁰ NS-NS merger events arise in binary systems of neutron stars

²⁰Also, in supernova explosions collimated jets of relativistic particles are emitted.

(NSs). In these systems, there are two NSs orbiting each other. In doing that, they lose energy by gravitational radiation and get closer and closer until they merge. The release of gravitational binding energy during the merging process, which occurs in the form of gravitational waves, neutrinos, and kinetic energy of jets of relativistic particles, is enormous and lasts just a few ms.²¹ In particular, the luminosity $L_{\text{NS-NS}}$ in the form of collimated jets of CR is of the order $L_{\text{NS-NS}} \sim 3.0 \cdot 10^{41} \cdot \text{erg} \cdot \text{s}^{-1}$. Such jets of CR have internal magnetic fields that prevent them from being deflected or losing their collimation. They are also not easily attenuated by the gas present in the interstellar medium and can be devastating for life if they encounter a planet on their trajectory. According to the estimations made in Dar *et al.* (1998), at a distance of ~ 1 kpc from the zone of the NS-NS merger, collimated jets of CR can deliver to that planet about 10^{12} TeV of energy during a period which goes from a day to 2 months. This quantity of energy is equivalent to the total energy deposition of GCR on Earth in the period of 10^7 years.

For completeness, we provide here the values of CR luminosity for some other sources of cosmic rays:

BL Lac objects (Uryson, 2004):

$$L_{\text{BL-Lac}} \sim 10^{42} \frac{\text{erg}}{\text{s}} \quad (32)$$

Seyfert galaxies (Uryson, 2004):

$$L_{\text{Seyfert}} \sim 10^{40} \frac{\text{erg}}{\text{s}} \quad (33)$$

Microquasars (Heinz and Sunyaev, 2002):

$$L_{\text{microquasar}} \sim 10^{37} - 10^{38} \frac{\text{erg}}{\text{s}} \quad (34)$$

To conclude this section, it is worth mentioning that, besides the influence of cosmic events, there are other situations that may increase the levels of CR on Earth. For example, an increase of CR fluxes could occur when the Solar System crosses the spiral arms of the Milky Way, a hypothesis proposed by Shaviv (2002, 2003).

6. Conclusions

In this work, a short account has been provided as to what is known about CR, starting from their properties and ending with the doses of ionizing radiation delivered to the human population. The sources of CR have been discussed only briefly and not in an exhaustive way in Section 5 because this argument is outside the aim of this article. Rather, we have focused on fluxes and intensities of CR and the particles that arrive on the ground as an effect of the cascades initiated by CR in the atmosphere. These quantities are of interest to scientists who work in different areas. Apart from research in high-energy physics and astronomy, the fluxes and intensities of particles of cosmic origin are also studied for radioprotection purposes [O'Brien *et al.*, 1996; UNSCEAR Report, Annex B (UNSCEAR, 2000a)] and for their capability to cause potentially harmful failures in computers and electronic storage devices (Ziegler, 1998). Fluxes of CR are also carefully

measured due to their relevance to space exploration; see for example SSP (NASA, 1994).

In the second part of this work, the notions of dosimetry that are relevant to astrobiology have been introduced. We have argued that the concepts of equivalent dose and effective dose are not suitable for astrobiology nor for the study of the effects of CR on evolution in particular. One should rather study the RBE of radiation and concentrate on its characteristics, which are present in wide classes of organisms.

Finally, in Appendix A the various kinds of fluxes and intensities of CR and related particles considered in research articles about CR are defined, and their meaning is illustrated. Concrete expressions for these quantities have been given in terms of mass densities, velocity distributions, and energy densities. Both relativistic and non-relativistic cases have been treated. To date, a systematic classification and explanation of these quantities, such as that provided in this work, has been missing in the scientific literature on CR. The necessity of filling this gap justifies the length of this Appendix.

Appendix A: Definitions of Intensity, Flux and Related Quantities

With regard to characterization of the intensity and flux of charged particles that arrive on Earth due to CR, there exists a plethora of observables. Their names and meanings may seem puzzling to the uninitiated. Moreover, the same observable is sometimes called a variety of names, depending on the author; or the same name may be used to describe two slightly different observables in different contexts. Also, it can be difficult to find an explanation of these observables in the scientific literature. Books on radiative transport often contain useful information (see for example Rybicki and Lightman, 1979); however, these books describe the intensity and flux of radiation emitted by an energy source. Here, we have instead dealt with intensity and flux of particles arriving at a detector. For these reasons, and to make this article self-contained, we attempt below to explain the meaning of the various quantities that are relevant to the physics of CR.

A.1. Differential directional intensity

The differential directional intensity (DDI) I_{ddi} is defined²² in such a way that the quantity

$$dN_i = I_{\text{ddi}} dS d\Omega dE_i dt \quad (35)$$

represents the number of particles of a given kind incident upon the infinitesimal element of area dS during the time dt within the element of solid angle $d\Omega$ perpendicular to dS and within the energy interval $[E_i, E_i + dE_i]$. The DDI has the meaning of number of particles incident upon the infinitesimal element of area dS per unit of energy, of time, and of solid angle. The index $i = 1, 2, 3 \dots$ labels the different kinds of particles (electrons, protons, muons, etc.). In principle, the DDI as defined above should depend on the index i , that is, $I_{\text{ddi}} = I_{\text{ddi}}^{(i)}$. However, we omit this index to simplify the notation.

To compute explicitly the I_{ddi} in terms of physical parameters like particle velocity and mass or energy density, we consider a point P in space, whose position with respect to a

²¹All the data presented here concerning NS-NS mergers are taken from Dar *et al.* (1998).

²²Here we follow Rossi (1948), in which a very clear and precise definition of the related concept of directional intensity is presented.

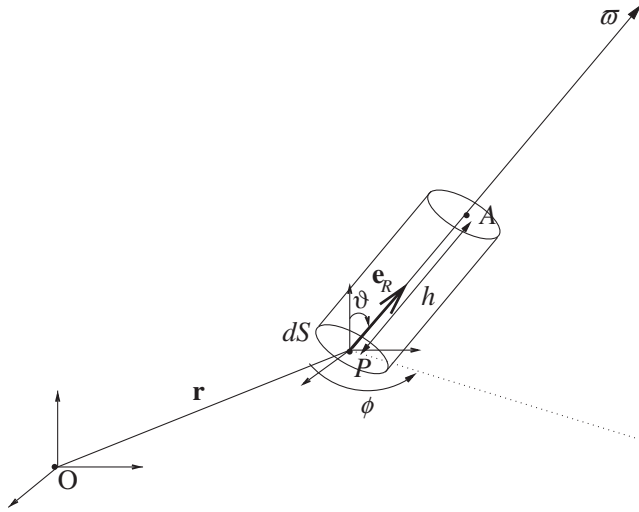

FIG. A1. This figure shows the geometrical setup for the definition of the differential directional intensity. The normal vector \mathbf{n} to the infinitesimal surface dS at the point P coincides with the vector \mathbf{e}_R , which gives the direction of the incoming particles. The particles that will be traversing the surface dS within the interval of time dt are those contained in the volume $h \cdot dS$, where $h = |\mathbf{v}_i| dt$.

Cartesian system of coordinates $Oxyz$ is given by the radius vector $\mathbf{r} = (x, y, z)$. In the following, it will be convenient to define a second reference system with origin in P and spherical coordinates w, ϑ, ϕ . The radial coordinate is w ($0 \leq w \leq +\infty$), while ϑ, ϕ represent the angular coordinates, defined in such a way that $0 \leq \vartheta \leq \pi$ and $0 \leq \phi \leq 2\pi$; see Fig. A1. We introduce also the infinitesimal vector element of surface $d\mathbf{S} = dS\mathbf{n}$. The area and the orientation of dS are given by dS and by the unit vector \mathbf{n} , which is normal to dS respectively. The element of surface dS is centered on the point P . Now we wish to count the number of particles of a certain type, e.g., electrons, which hit the surface dS in the unit of time and whose velocities \mathbf{v}_i are oriented according to a certain direction, given for instance by the unit vector $\mathbf{e}_R(\vartheta, \phi)$. Mathematically, this last condition is expressed as follows: $\mathbf{v}_i = |\mathbf{v}_i| \mathbf{e}_R(\vartheta, \phi)$. We will see that, in the case of the flux, the direction of $\mathbf{e}_R(\vartheta, \phi)$ may be arbitrary. However, in the case of the intensity, which we are treating here, the element of surface dS should be, by definition, perpendicular to the vector $\mathbf{e}_R(\vartheta, \phi)$. Equivalently, this means that the vector element of surface $d\mathbf{S}$ is parallel to $\mathbf{e}_R(\vartheta, \phi)$, that is,

$$\mathbf{n} = \mathbf{e}_R(\vartheta, \phi) \quad (36)$$

If particles are non-relativistic, as will be assumed throughout this subsection, it is possible to express the DDI in terms of the velocity and mass density of particles:²³

$$\mathbf{v}_i = |\mathbf{v}_i(E_i)| \mathbf{e}_R(\vartheta, \phi) \quad (37)$$

$$\rho_i = \rho_i(\mathbf{r}, \vartheta, \phi, E_i, t) \quad (38)$$

Here $\rho_i = \rho_i(\mathbf{r}, \vartheta, \phi, E_i, t)$ is defined in such a way that the quantity

$$dM(\mathbf{r}, \vartheta, \phi, E_i, t) = \rho_i(\mathbf{r}, \vartheta, \phi, E_i, t) dE_i d\Omega dV \quad (39)$$

coincides with the mass of particles contained in a small volume element centered at point P and at time t . Moreover, the velocities of the particles have directions spanning the element of solid angle $d\Omega$ and energies within the interval $[E_i, E_i + dE_i]$. Strictly speaking, one should call ρ_i specific (or differential) directional mass density.

The norm of the velocity \mathbf{v}_i is a function of the energy of the particle given by the well-known relationship

$$E_i = \frac{m_i}{2} |\mathbf{v}_i|^2 \quad (40)$$

Note that in Eq. 38 the distribution of density of mass ρ_i does not depend on the radial coordinate w . It can be seen below why it is not necessary to add the radial coordinate in the list of the arguments of ρ_i .

From Fig. A1 it is clear that the number of particles incident upon the surface dS from the specified directions centered around the element of solid angle $d\Omega$ and with energies in the interval $[E_i, E_i + dE_i]$ is given by

$$dN_{i, \mathbf{e}_R}(\mathbf{r}, \vartheta, \phi, E_i, t) = \frac{\rho_i}{m_i} |\mathbf{v}_i| d\mathbf{S} \cdot \mathbf{e}_R(\vartheta, \phi) dt dE_i d\Omega \quad (41)$$

To derive Eq. 41, the fact has been used that the total mass dM of the particles with the given characteristics traversing the surface dS in the interval of time dt is $dM = \rho_i |\mathbf{v}_i| d\mathbf{S} \cdot \mathbf{e}_R dt dE_i d\Omega$. The number of such particles is obtained after dividing the total mass dM by the mass m_i of a single particle of type i . In Eq. 41 the quantity $dN_{i, \mathbf{e}_R}(\mathbf{r}, \vartheta, \phi, E_i, t)$ still depends on the norm of the velocity \mathbf{v}_i . It is easy to rewrite it as a function of the kinetic energy E_i with use of Eq. 40. Finally, in Eq. 41 the scalar product $d\mathbf{S} \cdot \mathbf{e}_R(\vartheta, \phi)$, which represents the effective area hit by the particles incoming from the direction $\mathbf{e}_R(\vartheta, \phi)$, may be simplified, because the definition of DDI implies that the velocities of the particles are always perpendicular to the surface of dS , that is, parallel to $d\mathbf{S}$; see Eq. 36. Taking into account all the above remarks, it is possible to rewrite Eq. 41 as follows:

$$dN_{i, \mathbf{e}_R}(\mathbf{r}, \vartheta, \phi, E_i, t) = \frac{\rho_i}{m_i} |\mathbf{v}_i| dS dt dE_i d\Omega = \frac{\rho_i}{m_i} \sqrt{\frac{2E_i}{m_i}} dS dt dE_i d\Omega \quad (42)$$

Now we are in the position to understand why it is not necessary that the mass density depend on the radial coordinate w . The reason is that to compute the DDI just a small portion of space near the point P is considered, in which the radial coordinate is varying within the interval $[0, h]$, where h is an infinitesimal, since $h = |\mathbf{v}_i| dt$. Clearly, the variation of ρ_i with respect to the radial coordinate is negligible within this infinitesimal interval.

²³In the relativistic case, in which masses are not conserved, the energy density is more convenient than the density of mass. The relativistic case will be discussed in the next subsection.

Note that in real measurements, the number of particles coming from a particular direction is usually very small, so it is better to consider an entire set of directions, for instance, those characterized by slightly different angles ϑ' , ϕ' included within the range

$$\vartheta \leq \vartheta' \leq \vartheta + \Delta\vartheta \quad (43)$$

$$\phi \leq \phi' \leq \phi + \Delta\phi \quad (44)$$

where $\Delta\vartheta$ and $\Delta\phi$ denote finite quantities and not infinitesimal ones. Clearly, the unit vectors $\mathbf{e}_R(\vartheta', \phi')$ associated with these directions span a surface of area

$$A = \int_{\vartheta}^{\vartheta + \Delta\vartheta} d\vartheta' \sin \vartheta' \int_{\phi}^{\phi + \Delta\phi} d\phi' \quad (45)$$

on a sphere of unit radius; see Fig. A2. Always for experimental reasons, it will also be convenient to enlarge the set of possible particle energies to a finite interval

$$E_i \leq E'_i \leq E_i + \Delta E_i \quad (46)$$

The number of particles $dN_{i, \Delta\vartheta, \Delta\phi, \Delta E_i}(\mathbf{r}, \vartheta, \phi, E_i, t)$ with energy in the interval Eq. 46 and which arrive at the point P from all the directions spanning the area A of Eq. 45 on a sphere of unit radius is given by

$$dN_{i, \Delta\vartheta, \Delta\phi, \Delta E_i}(\mathbf{r}, \vartheta, \phi, E_i, t) = \int_{E_i}^{E_i + \Delta E_i} dE'_i \int_{\vartheta}^{\vartheta + \Delta\vartheta} d\vartheta' \int_{\phi}^{\phi + \Delta\phi} d\phi' \frac{\rho_i}{(m_i)^3} \sqrt{2E_i} \sin \vartheta' dS dt \quad (47)$$

To write the above equation, we used the fact that the infinitesimal element of solid angle $d\Omega'$ is given by:

$$d\Omega' = \sin \vartheta' d\vartheta' d\phi' \quad (48)$$

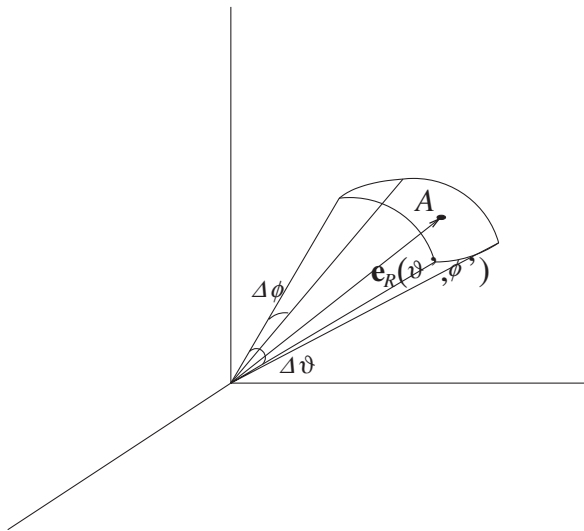

FIG. A2. Area A spanned on a sphere of unit radius by the unit vectors $\mathbf{e}_R(\vartheta', \phi')$. The values of ϑ' and ϕ' are defined in Eqs. 43 and 44.

Now, we go back to the computation of the DDI. It is easy to realize that the number of particles $dN_{i, \mathbf{e}_R}(\mathbf{r}, \vartheta, \phi, E_i, t)$ of Eq. 42 coincides with the number of particles entering in the definition of DDI of Eq. 35. Comparing these two equations, we find that

$$I_{ddi}(\mathbf{r}, \vartheta, \phi, E_i, t) = \frac{\rho_i}{(m_i)^3} \sqrt{2E_i} \quad (49)$$

Eq. 49 provides a nice relationship between the DDI and the mass density ρ_i . From Eq. 49 it turns out that the units in which the DDI is measured are $\text{cm}^{-2} \cdot \text{s}^{-1} \cdot \text{sr}^{-1} \cdot \text{GeV}^{-1}$, where sr is a shorthand for steradian, the unit of solid angles. In SI units, centimeters should be replaced with meters and GeV with joules.

We conclude this subsection with a few comments. As we have seen, the DDI gives detailed information on the number of particles arriving in the unit of time at a point P from a given direction and with a given energy. In Eq. 49, the DDI has been linked with the mass density of the incoming particles; later, we will see that it may also be related to the energy density of particles. As Eq. 47 shows, by integrating the DDI with respect to the angles (ϑ, ϕ) and the energy E_i , it is also possible to consider the intensity of particles arriving at P from a finite element of solid angle and with energies comprised in a given range.

It should be kept in mind that the DDI is an observable that is essentially related to the point P in which it is measured. The reason is that in the definition of the DDI the surface vector element $d\mathbf{S}$ is constrained to satisfy Eq. 36, *i.e.*, its direction coincides with the direction of the incoming particles for which we wish to measure the DDI. As a consequence, it makes no sense to interpret dS as the infinitesimal element of an extended surface S and to integrate the quantity I_{ddi} with respect to dS , pretending that the final result will describe some kind of intensity of particles passing through S .

Of course, in a real measurement the infinitesimal element of surface dS is necessarily approximated by a finite surface ΔS , which may be, for example, the sensor of some particle detector. However, if one wishes to measure the number of particles traversing an arbitrary finite surface S , one should introduce the concept of flux. This will be done in Subsection A.3.

A.1.1. Quantities related to the differential directional intensity. Starting from the differential directional intensity I_{ddi} , it is possible to integrate it with respect to various variables as we did, for example, in Eq. 47. Alternatively, one may consider the DDI for some values of its parameters; measuring, for instance, the DDI only for particles coming from the vertical direction, *i.e.*, in which $\vartheta = 0$. In this way, several other quantities²⁴ are constructed that are often encountered in the scientific literature. As mentioned in the introduction to Appendix A, there is a plethora of such quantities whose names at first glance appear to be

²⁴Note that all these quantities still have the meaning of particle intensities, in the sense explained above that they give information on particles incoming at a given point P .

TABLE A1. THE RECIPES FOR NAME CHANGING WHEN DIFFERENT KINDS OF MATHEMATICAL OPERATIONS ARE PERFORMED ON THE DDI

Operation	Change of name
$\lim_{\vartheta \rightarrow 0}$	directional \rightarrow vertical
$\int dE_i$	differential \rightarrow integral
$\int d\vartheta d\phi \sin \vartheta$	directional \rightarrow integrated

complicated. However, this is just an impression, because, as a matter of fact, the other intensities are usually derived from the DDI by performing (at least) one of only three different mathematical operations:

- (1) Integration with respect to the energy E_i : $\int dE_i$
- (2) Integration over the particle direction: $\int d\vartheta d\phi \sin \vartheta$.
- (3) Selection of the vertical direction: $\lim_{\vartheta \rightarrow 0}$.

Every time a mathematical operation of this kind is performed, the name of the resulting intensity can be obtained from the name of the starting intensity, according to the rules given in Table A1.

For example, integrating the DDI with respect to the energy, one obtains the integral directional intensity. If one further integrates the integral directional intensity over the directions spanning a given solid angle, the result is the integral integrated intensity. Below, the most important quantities which can be obtained in this way will be briefly described.

Integral directional intensity: The integral directional intensity (IDI) I_{idi} is obtained by integrating the DDI over some finite interval of energy $\Delta E_i = E_{i,max} - E_{i,min}$:

$$I_{idi}(\mathbf{r}, \vartheta, \phi, E_{i,min}, E_{i,max}, t) = \int_{E_{i,min}}^{E_{i,max}} I_{ddi}(\mathbf{r}, \vartheta, \phi, E_i, t) dE_i \quad (50)$$

where, of course, $E_{i,min} \geq 0$ because we are dealing with the kinetic energy of particles, which is a positive definite quantity. Moreover, $E_{i,max} \in [E_{i,min}, \infty]$. The units of I_{idi} are $\text{cm}^{-2} \cdot \text{s}^{-1} \cdot \text{sr}^{-1}$.

Differential vertical intensity: One of the observables that is commonly measured in experiments is the intensity of particles arriving at the surface of Earth from the vertical direction, which in our settings corresponds to the angle $\vartheta = 0$ of the spherical system of coordinates.²⁵ The DDI in the vertical direction is called the differential vertical intensity (DVI) I_{dvi} . The quantity I_{dvi} is defined as follows:

$$I_{dvi}(\mathbf{r}, E_i, t) = I_{ddi}(\mathbf{r}, \vartheta = 0, \phi, E_i, t) \quad (51)$$

Clearly, the DVI does not depend on ϕ because in the vertical direction $\vartheta = 0$ rotations around the z-axis make no sense. The same is true in the case of the integral vertical intensity

defined below. The units of DVI are the same as the units of the DDI.

Integral vertical intensity: The integral vertical intensity gives the number of particles coming from the vertical direction with respect to our coordinate system ϑ, ϕ and with energies comprised within the interval $[E_{i,min}, E_{i,max}]$ in units of $\text{cm}^{-2} \cdot \text{s}^{-1}$:

$$I_{ivi}(\mathbf{r}, t) = \int_{E_{i,min}}^{E_{i,max}} I_{ddi}(\mathbf{r}, \vartheta = 0, \phi, E_i, t) dE_i \quad (52)$$

Integrated intensity: The integrated intensity (II)²⁶ I_{ii} is defined as the integral of the DDI over all possible directions and energy values (Rossi, 1948):

$$I_{ii}(\mathbf{r}, t) = \int_0^{+\infty} dE_i \int_0^{2\pi} d\phi \int_0^\pi d\vartheta \sin \vartheta I_{ddi}(\mathbf{r}, \vartheta, \phi, E_i, t) \quad (53)$$

The integrated intensity is measured in units $\text{cm}^{-2} \cdot \text{s}^{-1}$. Of course, if one integrates the DDI only over all possible directions, but not over the energy, the result is a quantity which may be called the differential integrated intensity.

A.2. Energy density of particles and the intensity in the relativistic case

The specific directional density (SDD) $u_{sdd}(\mathbf{r}, \vartheta, \phi, E_i, t)$ is defined as the kinetic energy of particles of type i per unit of volume, of energy, and of solid angle. Sometimes the SDD is also called differential directional density. The quantity

$$dU = u_{sdd}(\mathbf{r}, \vartheta, \phi, E_i, t) dV dE_i d\Omega \quad (54)$$

represents the total kinetic energy carried by particles that are inside an element of volume dV and have velocities \mathbf{v}_i , whose directions span a small element of solid angle $d\Omega$ centered around the direction of the unit vector $\mathbf{e}_R(\vartheta, \phi)$. The norms of these velocities are determined by the condition that the energy of the particles must be within the infinitesimal interval $[E_i, E_i + dE_i]$. Clearly, the number of particles dN with the above characteristics that are inside the small volume dV at the time t is given by the total kinetic energy of the particles divided by the kinetic energy of each single particle:

$$dN = \frac{dU}{E_i} = u_{sdd}(\mathbf{r}, \vartheta, \phi, E_i, t) dV d\Omega \frac{dE_i}{E_i} \quad (55)$$

In the non-relativistic case, the relation between the kinetic energy E_i and the norm of the velocity $|\mathbf{v}_i|$ is provided by Eq. 40. In the relativistic case, this equation must be substituted with the following one:

$$|\mathbf{v}_i| = \frac{c}{E_i + m_i c^2} \sqrt{E_i^2 + 2m_i c^2 E_i} \quad (56)$$

The relativistic and non-relativistic expressions of the energy density u_{sdd} may be found in Landau and Lifshitz (1975) and

²⁵Sometimes one considers the intensity of particles in the near vertical direction, where the values of the angle ϑ between the trajectories of the particles and the gravity force spans over a finite interval, such as $0.9 \leq \sin \vartheta \leq 1$.

²⁶Strictly speaking, the name integrated integral intensity would be more correct.

Felsager (1981). Here, we will rather assume that u_{sdd} is known from observations.

At this point, we wish to derive the DDI for particles that attain relativistic speeds in terms of the energy density. We note to this purpose that the particles that will traverse the surface dS in the time dt while arriving from the direction perpendicular to dS are contained in the infinitesimal volume

$$dV = |\mathbf{v}_i| dS dt \quad (57)$$

The number of these particles is obtained from Eq. 55 after replacing in it the generic volume element dV with the right-hand side of Eq. 57. As a consequence, the number of particles dN_i of Eq. 35 may be expressed in terms of the SDD as follows:

$$dN_i = u_{\text{sdd}}(\mathbf{r}, \vartheta, \phi, E_i, t) |\mathbf{v}_i| dS dt d\Omega \frac{dE_i}{E_i} \quad (58)$$

Comparing Eq. 35 with Eq. 58, we obtain a relationship between the DDI and the SDD:

$$I_{\text{ddi}}(\mathbf{r}, \vartheta, \phi, E_i, t) = u_{\text{sdd}}(\mathbf{r}, \vartheta, \phi, E_i, t) \frac{c}{E_i^2 + m_i c^2 E_i} \sqrt{E_i^2 + 2m_i c^2 E_i} \quad (59)$$

where we have used Eq. 56 in order to write the speed $|\mathbf{v}_i|$ as a function of the energy E_i . Equation 59 is the analogue of Eq. 49 in the relativistic case with the mass density ρ_i replaced by the energy density u_{sdd} . Apparently, the relativistic DDI diverges with vanishing values of the energy E_i . However, this is not true. The reason is that at the point $E_i = 0$ the energy density u_{sdd} vanishes. Indeed, if every particle in a given system has energy equal to zero, the total energy of the system is also zero. As a result, in the limit in which E_i vanishes the right hand side of Eq. 59 remains finite.

At this point, the derivation of the related quantities of the DDI, such as the IDI or the DVI, proceeds as in the non-relativistic case of Subsection A.1. One has just to plug in the expression of the relativistic DDI given in Eq. 59 in the various formulas 50–53. For example, the IVI of Eq. 52 is given by

$$I_{\text{ivi}}^{\text{rel}}(\mathbf{r}, t) = \int_{E_i, \text{min}}^{E_i, \text{max}} u_{\text{sdd}}(\mathbf{r}, \vartheta = 0, \phi, E_i, t) \frac{c}{E_i^2 + m_i c^2 E_i} \sqrt{E_i^2 + 2m_i c^2 E_i} dE_i \quad (60)$$

where the superscript “rel” is used to point out that the above expression of the IVI is valid for relativistic particles.

Finally, following an analogous calculation of the total energy density of electromagnetic radiation presented in Rybicki and Lightman (1979), it is possible to compute the total kinetic energy density (TED) $u_{\text{ted}}(\mathbf{r}, t)$ of the particles per unit of volume

$$u_{\text{ted}}(\mathbf{r}, t) = \int_0^{+\infty} dE_i \int d\Omega \frac{E_i^2 + m_i c^2 E_i}{c \sqrt{E_i^2 + 2m_i c^2 E_i}} I_{\text{ddi}}(\mathbf{r}, \vartheta, \phi, E_i, t) \quad (61)$$

The energy density E_D^{CR} used in Section 5 may be regarded as the average of the TED over a long time period τ and over a sufficiently big volume V :

$$E_D^{\text{CR}} = \int_0^\tau \frac{dt}{\tau} \int \frac{d^3x}{V} u_{\text{ted}}(\mathbf{r}, t) \quad (62)$$

A.3. Differential directional flux and related quantities

The definition of the differential directional flux (DDF) Φ_{ddf} is very similar to that of the DDI. The difference is that, in the case of the DDF, the direction of the normal \mathbf{n} to the element of surface dS does not need to coincide with the direction of the velocity of the incoming particles $\mathbf{e}_R(\vartheta, \phi)$. More precisely, the DDF is defined in such a way that the quantity

$$dN_{i, \mathbf{e}_R}^f = \Phi_{\text{ddf}} dS dt dE_i d\Omega \quad (63)$$

represents the number of particles of a given kind traversing the infinitesimal surface element dS during the time dt within the element of solid angle $d\Omega$ and within the energy interval $[E_i, E_i + dE_i]$. The superscript f has been added to remember that now a flux is being computed and not an intensity.

To compute the DDF, we imagine that we wish to measure it in a neighborhood of a point P . Due to the fact that such measurements are usually performed on the ground, we assume that the point P is very near (a few meters or less) to the surface of Earth. This assumption has been made with the sole purpose to fix the ideas, but there is nothing deep in it. In the case of space-based measurements, one could replace the ground with the walls of a spaceship or of a satellite. What matters is that, in the end, the definition of the flux obtained is entirely general.

The particle detector is approximated as a small and flat surface, which is centered on P . One side of the surface, on which there are sensors able to detect the fluxes of incoming particles, is always directed toward the sky, while the opposite side is pointing toward the ground; see Fig. A3.

We introduce an infinitesimal element of surface dS , which represents the detector, and we choose a system of

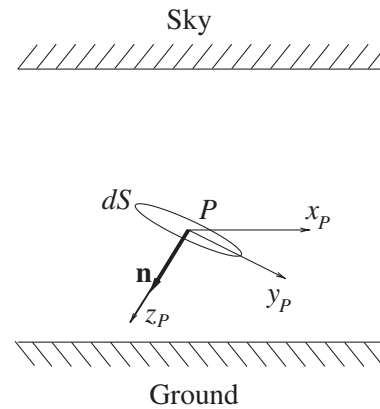

FIG. A3. This figure shows the schematic experimental setup used to measure the flux of particles of cosmic origin on the ground. The detector is represented as an infinitesimal element of surface dS . The active part of the detector is on the upper side of the surface, which points toward the sky.

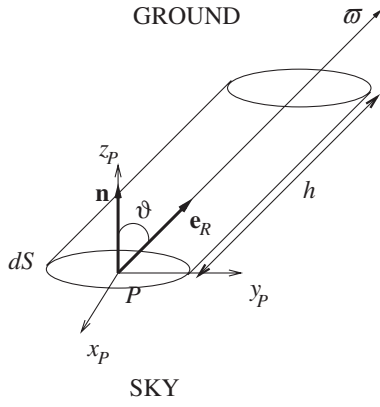

FIG. A4. This figure shows the geometrical setup for the definition of the differential directional flux. The normal vector \mathbf{n} to the infinitesimal surface dS at the point P makes an angle ϑ with the vector $\mathbf{e}_R(\vartheta, \phi)$, which gives the direction of the incoming particles. The particles of type i with velocity $|\mathbf{v}_i| \mathbf{e}_R(\vartheta, \phi)$ that will traverse the surface dS within the interval of time dt are those contained in the volume $h \cdot dS \cos \vartheta$, where $h = |\mathbf{v}_i| dt$.

coordinates x_p, y_p, z_p at the point P in such a way that dS lies in the horizontal plane $z_p = 0$. Passing to polar coordinates $x_p, y_p, z_p \rightarrow \varpi, \vartheta, \phi$ this means that the direction of the unit vector \mathbf{n} which is normal to dS is given by the angle $\vartheta = 0$. Furthermore, the orientation of \mathbf{n} is such that it points downward, *i.e.*, toward the ground. Since we are measuring only particles which traverse the upper side of the surface dS in a downward sense, this implies that:

$$\mathbf{n} \cdot \mathbf{e}_R(\vartheta, \phi) = \cos \vartheta \geq 0 \quad (64)$$

i.e., the normal vector \mathbf{n} and the particle velocity $|\mathbf{v}_i| \mathbf{e}_R(\vartheta, \phi)$ form an angle ϑ ; see Fig. A4. Clearly, Eq. 64 is satisfied only in the interval $0 \leq \vartheta \leq \frac{\pi}{2}$. The volume of particles dV , which will traverse dS coming from the direction $\mathbf{e}_R(\vartheta, \phi)$, is shown in Fig. A4 and is given by $dV = |\mathbf{v}_i| dt \cos \vartheta dS$.

The number of those particles in the non-relativistic case is thus

$$dN_{i, \mathbf{e}_R}^f = \frac{\rho_i |\mathbf{v}_i|}{m_i} dS dt dE_i d\Omega \cos \vartheta \quad (65)$$

This is the analogue of Eq. 42 in the case of the flux.²⁷ The factor $\cos \vartheta$ results from evaluating the scalar product $\mathbf{n} \cdot \mathbf{e}_R(\vartheta, \phi)$ in Eq. 41 via Eq. 64. As already mentioned in

²⁷In the relativistic case, this equation must be substituted by:

$$dN_{i, \mathbf{e}_R}^f = u_{sdd}(\mathbf{r}, \vartheta, \phi, E_i, t) |\mathbf{v}_i| \frac{dE_i}{E_i} dS dt d\Omega \cos \vartheta \quad (66)$$

where we have used Eq. (58) in order to count the number of particles of type i with velocity $|\mathbf{v}_i| \mathbf{e}_R(\vartheta, \phi)$ traversing the surface dS within the interval of time dt . As we note, in the relativistic formula the mass density ρ_i has been substituted by the energy density u_{sdd} .

Subsection A.1., the number of particles coming from a given direction is usually very small. For this reason, in real measurements it is better to consider particles coming from different directions and carrying different energies, instead of focusing on a particular direction and a particular energy. We should only remember that in the present case the orientation of the surface dS remains fixed; what is changing is the direction of the incoming particles.

The procedure for obtaining the differential directional flux starting from Eq. 65 is entirely similar to that used in deriving the explicit expression for the DDI of Eq. 49, starting from Eq. 42. Thus, we just give the result of the calculation:

$$\Phi_{ddf}(\mathbf{r}, \vartheta, \phi, E_i, t) = \frac{\rho_i}{(m_i)^3} \sqrt{2E_i} \cos \vartheta \quad (67)$$

The units of the DDF are the same as the units of the DDI.

It is also possible to derive a relation between the DDF and the SDD that is analogous to Eq. 59 in the case of the DDI. This is a straightforward exercise. The particles traversing the surface dS in the time dt , which arrive from the direction $\mathbf{e}_R(\vartheta, \phi)$, are contained in the infinitesimal volume:

$$dV = |\mathbf{v}_i| dS \cdot \mathbf{e}_R(\vartheta, \phi) = |\mathbf{v}_i| dS dt \cos \vartheta \quad (68)$$

as shown in Fig. A4 and related comments. At this point, we use the definition of the SDD from Eq. 55 and follow the same steps that led to the relationship of Eq. 59 between the DDI and the SDD. From Eq. 55, it turns out that the number of particles contained in the volume of Eq. 68 is

$$dN_{i, \mathbf{e}_R}^f = u_{sdd}(\mathbf{r}, \vartheta, \phi, E_i, t) |\mathbf{v}_i| \cos \vartheta dS dt d\Omega \frac{dE_i}{E_i} \quad (69)$$

where $|\mathbf{v}_i|$ may be derived as usual as a function of the kinetic energy E_i from Eq. 40 in the non-relativistic case and from Eq. 56 in the relativistic case. At this point, we note that the number of particles dN_{i, \mathbf{e}_R}^f given in Eq. 69 coincides with the number of particles dN_{i, \mathbf{e}_R}^f of Eq. 63. Comparing these two equations, we obtain the desired relation between the DDF and the SDD. Assuming, for example, that our particles are relativistic, this relation looks as follows:

$$\Phi_{ddf} = u_{sdd}(\mathbf{r}, \vartheta, \phi, E_i, t) \frac{c \sqrt{E_i^2 + 2m_i c^2 E_i}}{E_i^2 + m_i c^2 E_i} \cos \vartheta \quad (70)$$

This is, of course, the straightforward generalization of Eq. 59 in the case in which the incoming particles are allowed to arrive from a direction $\mathbf{e}_R(\vartheta, \phi)$, which is not parallel to dS if $\vartheta \neq 0$.

A.3.1. Observables related to the DDF. In analogy with what has been done in the case of the intensities, one may construct other observables starting from the DDF. For example, after integrating the DDF with respect to the energy one obtains the **integral directional flux**, while the **differential vertical flux** corresponds to the value of the DDF in the case $\vartheta = 0$. Note that the differential vertical flux coincides with the DVI. The rules of name changing are the same as those reported in Table A1 in the case of the intensities.

The **differential integrated flux** $\Phi(\mathbf{r}, E_i, t)$, which is what is commonly called flux, is defined in such a way that the quantity $dN_{i, \text{int}}^f = \Phi(\mathbf{r}, E_i, t) dS dt dE_i$ coincides with the number of particles of a given kind and of given energy E_i traversing in a downward sense²⁸ the element of surface dS :

$$\Phi(\mathbf{r}, E_i, t) = \int_0^{\frac{\pi}{2}} d\vartheta \int_0^{2\pi} d\phi \Phi_{\text{ddf}}(\mathbf{r}, \vartheta, \phi, E_i, t) \sin \vartheta \quad (71)$$

The subscript ‘‘int’’ in $dN_{i, \text{int}}^f$ means integrated, and it refers to the fact that, to derive $\Phi(\mathbf{r}, E_i, t) dS dt$, one needs an integration over $d\Omega$. This flux can be measured in units $\text{cm}^{-2} \cdot \text{s}^{-1} \cdot \text{GeV}^{-1}$. Starting from the expression of $\Phi(\mathbf{r}, E_i, t)$, it is possible to compute the integral integrated flux, often called **total flux**:

$$\Phi(\mathbf{r}, t) = \int_{E_{i, \text{min}}}^{E_{i, \text{max}}} \Phi(\mathbf{r}, E_i, t) dE_i \quad (72)$$

Analogously, it is possible to define the **total energy flux** $\Phi_E(\mathbf{r}, t)$:

$$\Phi_E(\mathbf{r}, t) = \int_{E_{i, \text{min}}}^{E_{i, \text{max}}} \Phi(\mathbf{r}, E_i, t) E_i dE_i \quad (73)$$

$\Phi_E(\mathbf{r}, t)$ represents the total kinetic energy carried by particles per unit of area and of time.

The concept of flux is usually connected with vector fields. In the present case, the vector field is provided by the so-called differential directional intensity field (DDI field)

$$\mathbf{I}_{\text{ddi}} = I_{\text{ddi}} \mathbf{e}_R \quad (74)$$

where \mathbf{e}_R is the unit vector that defines the direction of the velocity of particles. In terms of the DDI field, the flux may be expressed as follows:

$$\Phi(\mathbf{r}, E_i, t) = \int d\Omega \mathbf{I}_{\text{ddi}} \cdot \mathbf{n} \quad (75)$$

according to the usual definition of flux.

Contrarily to the DDI, the DDF may also be integrated with respect to the element of area dS . This fact allows for definition of the flux of particles traversing an extended surface S . To compute the flux of particles in the case of an extended surface S , it is convenient to parameterize this surface with two parameters σ_1 and σ_2 , so that a point of S in the space will be denoted by the triplet of Cartesian coordinates $x(\sigma_1, \sigma_2)$, $y(\sigma_1, \sigma_2)$ and $z(\sigma_1, \sigma_2)$ or, shortly, by the radius vector $\mathbf{r}(\sigma_1, \sigma_2)$. For each point P of the surface, corresponding to a given value of the parameters σ_1 and σ_2 , we have seen that it is possible to compute the differential flux of particles $\Phi[\mathbf{r}(\sigma_1, \sigma_2), E_i, t]$ traversing a small element dS of S . The flux $\Phi_S(E_i, t)$ of particles incoming upon S per unit of

energy and time is obtained by integrating $\Phi(\mathbf{r}(\sigma_1, \sigma_2), E_i, t)$ with respect to dS , where dS will now depend on σ_1 and σ_2 :

$$\Phi_S(E_i, t) = \int_S \Phi(\mathbf{r}(\sigma_1, \sigma_2), E_i, t) dS(\sigma_1, \sigma_2) \quad (76)$$

Acknowledgments

The authors are indebted to the anonymous referees for many invaluable suggestions which have greatly improved this article. This work was partially supported by MNIWS grants N203 026 32/3831 and N202 156 31/2933.

Abbreviations

ACR, anomalous cosmic rays; CR, cosmic rays; DDF, differential directional flux; DDI, differential directional intensity; DVI, differential vertical intensity; EDR, effective dose rate; GCR, galactic cosmic rays; GZK, Greisen-Zatsepin-Kuzmin; ICRP, International Commission on Radiological Protection; IDI, integral directional intensity; II, integrated intensity; IVI, integral vertical intensity; KERMA, kinetic energy released in unit of mass; LET, linear energy transfer; NS, neutron star; RBE, relative biological effectiveness; SCR, solar energetic particles; SDD, specific directional density; SNRs, supernova remnants; TED, total kinetic energy density; UHECR, ultrahigh-energy cosmic rays.

References

- Abraham, J., Aglietta, M., Aguirre, I.C., Albrow, M., Allard, D., Allekotte, I., Allison, P., Alvarez Muñiz, J., do Amaral, M.G., Ambrosio, M., Anchordoqui, L., Andrews, R., Anguiano, M., dos Anjos, J.C., Aramo, C., Argiro, S., Arisaka, K., Arteaga, J.C., Atulugama, S., *et al.* (2004) Properties and performance of the prototype instrument for the Pierre Auger Observatory. *Nucl. Instrum. Methods Phys. Res. A* 523:50–95.
- Allan, H.R. (1971) Radio emission from extensive air showers. In *Progress in Elementary Particle and Cosmic Ray Physics*, Vol. 10, edited by J.G. Wilson and S.A. Wouthuysen, North Holland Publishing Co., Amsterdam, p 171.
- Allkofer, O.C. (1975) *Introduction to Cosmic Radiation*, Verlag Karl Thieme, München, Germany.
- Allkofer, O.C., Carstensen, K., and Dau, W.D. (1971) The absolute cosmic ray muon spectrum at sea level. *Phys. Lett. B* 36:425–427.
- Amenomori, M., Cao, Z., *et al.* (1995) Antiproton proton ratio at 10^{13} eV inferred from the superposition of sun shadows using the Tibet air shower. In *Proceedings of the 24th International Cosmic Ray Conference*, Vol. 3, edited by N. Iucci and E. Lamanna, International Union of Pure and Applied Physics, College Park, MD, p 84.
- Anchordoqui, L.A., Paul, T., Reucroft, S., and Swain, J. (2003) Ultrahigh energy cosmic rays: the state of the art before the Auger Observatory. *Int. J. Mod. Phys. A* 18:2229–2366.
- Arrage, A.A., Phelps, T.J., Benoit, R.E., and White, D.C. (1993) Survival of subsurface microorganisms exposed to UV radiation and hydrogen peroxide. *Appl. Environ. Microbiol.* 59:3545–3550.
- Babcock, E.B. and Collins, J.L. (1929) Does natural ionizing radiation control rate of mutation? *Proc. Natl. Acad. Sci. U.S.A.* 15:623–629.
- Battistoni, G. and Grillo, A.F. (1996) Introduction to high energy cosmic ray physics. In *The Proceedings of the Fourth ICTP School*

²⁸We recall that, here, downward means that the angle between the normal vector \mathbf{n} and the vector \mathbf{e}_R , which determines the direction of the particle velocity, must be within the range $[0, \frac{\pi}{2}]$.

- on *Nonaccelerator Particle Astrophysics*, edited by E. Bellotti, R.A. Carrigan, G. Giacomelli, and N. Paver, World Scientific, Singapore, pp 341–375.
- Belisheva, N.K., Semenov, V.S., Tolstiy, Yu. V., and Biernat, H.K. (2002) Solar flares, generation of solar cosmic rays, and their influence on biological systems. In *Proceedings of the 1st European Workshop on Exo-Astrobiology*, 16–19 September 2002, Graz, Austria, edited by H. Lacoste, ESA SP-518, ESA Publication Division, Noordwijk, the Netherlands, pp 429–430.
- Berezovsky, I.N. and Trifonov, E.N. (2001) Protein structure and folding: a new start. *J. Biomol. Struct. Dyn.* 19:397–403.
- Bergman, D.R. and Belz, J.W. (2007) Cosmic rays: the Second Knee and beyond. *J. Phys. G Nucl. Part. Phys.* 34:R359–R400.
- Bertou, X., Boratav, M., and Letessier-Selvon, A. (2000) Physics of extremely energetic cosmic rays. *Int. J. Mod. Phys. A* 15: 2181–2224.
- Bhattacharjee, P. and Sigl, G. (2000) Origin and propagation of extremely high energy cosmic rays. *Phys. Rep.* 327:109–247.
- Bhattacharyya, D.P. (1976) Vertical sea-level muon spectrum at solar minimum near geomagnetic equator in the momentum range 0.5–3 GeV/c. *Phys. Rev., D* 13:1851–1855.
- Biermann, P. and Sigl, G. (2001) Introduction to cosmic rays. *Lecture Notes in Physics* 576:1–26.
- Bréchnignac, F., Brown, J., Coppelstone, D., Domotor, S., Howard, B., Hunter, G., Mobbs, H., Oughton, D., Pentreath, J., Robinson, C., Woodhead, D., and Zhu, Y. (2002) Protection of the environment. Current status and future work. *IUR Report 03*, Copyshop, Oslo, pp 1–24. Also available online at <http://www.iur-uir.org>.
- Carlsaw, K.S., Harrison, R.G., and Kirkby, J. (2002) Cosmic rays, clouds, and climate. *Science* 298:1732–1737.
- Clay, R.W., Smith, A.G.K., and Reid, J.L. (1997) Cosmic ray induced noise in gravitational wave detectors. *Publications of the Astronomical Society of Australia* 14:195–199.
- Clay, R.W., Kurban, Z., and Wild, N.R. (1998) *Cosmic Ray Related Undergraduate Experiments, GAP Note 1998-061*, Technical and Scientific Notes about the Pierre Auger Project, Pierre Auger Collaboration. Also available online at http://www.auger.org/admin/GAP_Notes/index.html.
- Clem, J.M., Clements, D., et al. (1995) Flux of cosmic ray neutrons at 1.5 GeV. In *Proceedings of the 24th International Cosmic Ray Conference*, Vol. 3, edited by N. Iucci and E. Lamanna, International Union of Pure and Applied Physics, College Park, MD, p 5.
- COESA (U.S. Committee on Extension to the Standard Atmosphere). (1976) *U.S. Standard Atmosphere*, U.S. Government Printing Office, Washington DC.
- Cockell, C.S. and Knowland, J. (1999) Ultraviolet radiation screening compounds. *Biological Reviews* 74:311–345.
- Cronin, J.W. (1999) Cosmic rays: the most energetic particles in the universe. *Reviews of Modern Physics* 71:S165–S172.
- Cronin, J.W. (2004) The highest-energy cosmic rays. Talk presented at TAUP 2003, Seattle, USA, arXiv: astro-ph/0402487.
- Cronin, J.W., Gaisser, T.K., and Swordy, S.P. (1997) Cosmic rays at the energy frontier. *Sci. Am.* 276:44–50.
- Cummings, A.C., McDonald, F.B., Heikkila, B.C., Lal, N., Weber, W.R., and Stone, E.C. (2008) An asymmetric solar wind termination shock. *Nature* 454:71–74.
- Dar, A. (1983) Atmospheric neutrinos, astrophysical neutrons, and proton-decay experiments. *Phys. Rev. Lett.* 51:227–230.
- Dar, A., Laor, A., and Shaviv, N.J. (1998) Life extinctions by cosmic ray jets. *Phys. Rev. Lett.* 80:5813–5816.
- Dedenko, L.G. and Zatsepin, G.T. (2005) Cosmic rays of ultra-high energy. *Physics of Atomic Nuclei* 68:420–438.
- Desilets, D. and Zreda, M. (2001) On scaling cosmogenic nuclide production rates for altitude and latitude using cosmic-ray measurements. *Earth Planet. Sci. Lett.* 193:213–225.
- DOE (U.S. Department of Energy). (1999) Radiological control technician training. In *DOE Handbook DOE-HDBK-1122-99*, Module 1.07, U.S. Department of Energy, Washington, DC. Also available online at <http://www.hss.doe.gov/nuclearsafety/ns/techstds/standard/hdbk1122/rad.html>.
- Dorman, L.I. (2004) *Cosmic Rays in the Earth's Atmosphere and Underground*, *Astrophysics and Space Science Library*, Vol. 303, Kluwer Academic Publishers, Dordrecht, the Netherlands.
- Eidelman, S., Hayes, K.G., Olive, K.A., Aguilar-Benitez, M., Amsler, C., Asner, D., Babu, K.S., Barnett, R.M., Beringer, J., Burchat, P.R., Carone, C.D., Caso, S., Conforto, G., Dahl, O., D'Ambrosio, G., Doser, M., Feng, J.L., Gherghetta, T., Gibbons, L., et al. (2004) The review of particle physics. *Phys. Lett. B* 592:1–1109.
- Falcke, H. and Gorham, P. (2002) Detecting radio emission from cosmic ray air showers and neutrinos with LOFAR. LOFAR Scientific Memorandum #3, LOFAR.
- Farrar, G.R. and Piran, T. (2000) Violation of the Greisen-Zatsepin-Kuzmin Cutoff: a tempest in a (magnetic) teapot? Why cosmic ray energies above 10^{20} eV may not require new physics. *Phys. Rev. Lett.* 84:3527–3530.
- Felsager, B. (1981) *Geometry, Particles and Fields*, Odense University Press, Odense, Denmark.
- Fichtner, H. (2001) Anomalous cosmic rays: messengers from the outer heliosphere. *Space Sci. Rev.* 95:639–754.
- Fowler, J.W., Fortson, L.F., Jui, C.C.H., Kieda, D.B., Ong, R.A., Pryke, C.L., and Sommers, P. (2001) A measurement of the cosmic ray spectrum and composition at the knee. *Astroparticle Physics* 15:49–64.
- Friedlander, M.W. (2000) *Thin Cosmic Rain: Particles from Outer Space*, Harvard University Press, Cambridge, MA.
- Gaisser, T.K. (1990) *Cosmic Rays and Particle Physics*, Cambridge University Press, Cambridge.
- Gilmour, I. and Sephton, M.A. (2004) *An Introduction to Astrobiology*, Cambridge University Press, Cambridge.
- Greider, P.K.F. (2001) *Cosmic Rays at Earth*, Elsevier Science, St. Louis, MO.
- Greisen, K. (1966) End to the cosmic-ray spectrum? *Phys. Rev. Lett.* 16:748–750.
- Grießmeier, J.-M., Stadelmann, A., Motschmann, U., Belisheva, N.K., Lammer, H., and Biernat, H.K. (2005) Cosmic ray impact on extrasolar Earth-like planets in close-in habitable zones. *Astrobiology* 5:587–603.
- Heinz, S. and Sunyaev, R. (2002) Cosmic rays from microquasars: a narrow component to the CR spectrum? *Astron. Astrophys.* 390:751–766.
- Hess, V.F. (1912) Ueber Beobachtungen der durchdringenden Strahlung bei sieben Freiballonfahrten. *Physikalische Zeitschrift* 13:1084–1091.
- Horneck, G. (1992) Radiobiological experiments in space: a review. *Int. J. Rad. Appl. Instrum. D* 20:185–205.
- Horneck, G., Facius, R., Reitz, G., Rettberg, P., Baumstark-Khan, C., and Gerzer, R. (2001) Critical issues in connection with human planetary missions: protection of and from the environment. *Acta Astronaut.* 49:279–288.
- IAEA (International Atomic Energy Agency). (2001) *Cytogenetic Analysis for Radiation Dose Assessment: A Manual*, Technical Report Series No. 405, International Atomic Energy Agency, Vienna.
- ICRP (International Commission on Radiological Protection). (1991a) *Recommendations of the International Commission on*

- Radiological Protection*, ICRP Publication 60, *Annals of the ICRP* 21:1–3, Pergamon Press, Oxford.
- ICRP (International Commission on Radiological Protection). (1991b) Relative biological effectiveness (RBE), quality factor (Q), and radiation weighting factor w_R . ICRP Publication 92, edited by J. Valentin, *Annals of the ICRP* 33:4, Pergamon Press, Oxford.
- Klecker, B., Mewaldt, R.A., Bieber, J.W., Cummings, A.C., Drury, L., Giacalone, J., Jokipii, J.R., Jones, F.C., Kranev, M.B., Lee, M.A., Le Roux, J.A., Marsden, R.G., McDonald, F.B., McKibben, R.B., Steenberg, C.D., Baring, M.G., Ellison, D.C., Lanzerotti, L.J., Leske, R.A., Mazur, J.E., Moraal, H., Oetliker, M., Ptuskin, V.S., Selesnick, R.S., and Trattner, K.J. (1998) Anomalous cosmic rays. *Space Sci. Rev.* 83:259–308.
- Kminek, G., Bada, J.L., Pogliano, K., and Ward, J.F. (2003) Radiation-dependent limit for the viability of bacterial spores in halite fluid inclusions and on Mars. *Radiat. Res.* 159: 722–729.
- Landau, L.D. and Lifshitz, E.M. (1975) *The Classical Theory of Fields*, Pergamon Press, Oxford.
- Lee, R.C., Feinbaum, R.L., and Ambros, V. (1993) The *C. elegans* heterochronic gene *lin-4* encodes small RNAs with antisense complementarity to *lin-14*. *Cell* 75:843–854.
- Luria, S.E. and Delbrück, M. (1943) Mutations of bacteria from virus sensitivity to virus resistance. *Genetics* 28:491–511.
- McComas, D.J., and Schwadron, N.A. (2006) An explanation of the Voyager paradox: particle acceleration at a blunt termination shock. *Geophys. Res. Lett.* 33:L04102.1–L04102.5.
- Medvedev, M.V. and Melott, A.L. (2007) Do extragalactic cosmic rays induce cycles in fossil diversity? *Astrophys. J.* 664: 879–889.
- Mewaldt, R.A. (1996) Cosmic rays. In *MacMillan Encyclopedia of Physics*, MacMillan, New York.
- Miroshnichenko, L.I. (2001) *Solar Cosmic Rays*, Kluwer Academic Publishers, Dordrecht, the Netherlands.
- Moreira, R.G. (BSEN-625) Radiation dosimetry. Material for the course on Advances in Food Engineering BSEN-625, Texas A&M University, College Station, Texas. Also available online at <http://moreira.tamu.edu/BAEN625/BAEN625.html> (accessed April 2009).
- O'Brien, K., Friedberg, W., Sauer, H.H., and Smart, D.F. (1996) Atmospheric cosmic rays and solar energetic particles at aircraft altitudes. *Environ. Int.* 22:59–S44.
- Olbert, S. (1953) Atmospheric effects on cosmic-ray intensity near sea level. *Physical Review* 92:454–461.
- Orito, S., et al. (1995) Observation of antiprotons at low energies by BESS detector. In *Proceedings of the 24th International Cosmic Ray Conference*, Vol. 3, edited by N. Iucci and E. Lamanna, International Union of Pure and Applied Physics, College Park, MD, p 76–79.
- Pierog, T., Engel, R., and Heck, D. (2005) Impact of uncertainties in hadron production on air-shower predictions. *Czechoslovak Journal of Physics* 56:A161–A172.
- Rachen, J.P. and Bierman, P.L. (1993) Extragalactic ultra-high energy cosmic-rays—part one—contribution from hot spots in Fr-II radio galaxies. *Astron. Astrophys.* 272:161–175.
- Rand, R.J. and Kulkarni, S.R. (1989) The local galactic magnetic field. *Astrophys. J.* 343:760–772.
- Rossi, B. (1948) Interpretation of cosmic-ray phenomena. *Reviews of Modern Physics* 20:537–583.
- Ruvkun, G. (2001) MOLECULAR BIOLOGY: Glimpses of a Tiny RNA World. *Science* 294:797–799.
- Ryan, J.M., Lockwood, J.A., and Debrunner, H. (2000) Solar energetic particles. *Space Sci. Rev.* 93:35–53.
- Rybicki, G.B. and Lightman, A.P. (1979) *Radiative Processes in Astrophysics*, John Wiley and Sons, New York.
- Sagan, C. and Shklovskii, I.S. (1966) *Intelligent Life in the Universe*, Holden-Day, San Francisco.
- Satta, L., Antonelli, F., Belli, M., Saporita, O., Simone, G., Sorrentino, E., Tabocchini, M.A., Amicarelli, F., Ara, C., Cerù, M.P., Colafarina, S., Conti Devirgiliis, L., De Marco, A., Balata, M., Falgiani, A., and Nisi, S. (2002) Influence of a low background radiation environment on biochemical and biological responses in V79 cells. *Radiat. Environ. Biophysics* 41:217–224.
- Seo, E.S., McDonald, F.B., Lai, N., and Weber, W.R. (1994) Study of cosmic-ray H and He isotopes at 23 AU. *Astrophys. J.* 432:656–664.
- Shaviv, N.J. (2002) Cosmic ray diffusion from the galactic spiral arms, iron meteorites, and a possible climatic connection. *Phys. Rev. Lett.* 89:051102.
- Shaviv, N.J. (2003) Toward a solution to the early faint Sun paradox: a lower cosmic ray flux from a stronger solar wind. *J. Geophys. Res.* 108, doi:10.1029/2003JA009997.
- Shea, M.A. and Smart, D.F. (2000) Cosmic ray implications for human health. *Space Sci. Rev.* 93:187–205.
- Sinnis, C., Dingus, B.L., Haines, T.J., Hoffman, C.M., Samuelson, F.W., Gisler, G.R., Atkins, R., Gonzalez, M.M., McEnery, J.E., Wilson, M.E., Benbow, W., Coyne, D.G., Dorfan, D.E., Kelley, L.A., Morales, M.F., Williams, D.A., Westerhoff, S., Berley, D., Blaufuss, E., Bussons, J., Goodman, J.A., Hays, E., Lansdell, C.P., Noyes, D., Smith, A.J., Sullivan, G.W., DeYoung, T., Ellsworth, R.W., Fleysher, L., Fleysher, R., Mincer, A.I., Nemethy, P., Linnemann, J., Xu, X., Miller, R.S., Ryan, J.M., Shoup, A., and Yodh, G.B. (2003) Teravolt astrophysics—the Milagro Gamma-Ray Observatory. In *Physics Division Activity Report January 1–December 31, 2003*, Los Alamos National Laboratory, Los Alamos NM, pp 145–148. Also available online at http://www.lanl.gov/p/prog_rpt.shtml.
- Sokolsky, P. (1989) *Introduction to Ultrahigh Energy Cosmic Ray Physics*, Addison-Wesley, New York.
- NASA (1994) *Space Station Ionizing Radiation Design Environment: International Space Station Alpha*, SSP 30512 revision C, NASA, Johnson Space Flight Center, Houston, Texas.
- Stanev, T. (2004) *High Energy Cosmic Rays*, Praxis/Springer-Verlag, New York.
- Strong, A.W. and Moskalenko, I.V. (2001) SNR and fluctuations in the diffuse galactic γ -ray continuum. In *Gamma 2001: Gamma-Ray Astrophysics*, AIP Conference Proceedings 587, edited by S. Ritz, C.R. Shrader, and N. Gehrels, American Institute of Physics, Melville, NY, pp 533–537.
- Torres, D.F. and Anchordoqui, L.A. (2004) Astrophysical origins of ultrahigh energy cosmic rays. *Reports on Progress in Physics* 67:1663–1730.
- Trimble, V., Aschwanden, M.J., and Hansen, C.J. (2006) Astrophysics in 2005. *Publ. Astron. Soc. Pac.* 118:947–1047.
- UNSCEAR (United Nations Scientific Committee on the Effects of Atomic Radiation). (2000a) *Sources and Effects of Ionizing Radiation, Annex B: Exposures from Natural Radiation Sources*, UNSCEAR 2000 Report, UNSCEAR, Vienna.
- UNSCEAR. (2000b) *Sources and Effects of Ionizing Radiation, Annex F: DNA Repair and Mutagenesis*, UNSCEAR 2000 Report, UNSCEAR, Vienna.
- UNSCEAR. (2000c) *Sources and Effects of Ionizing Radiation, Annex G: Biological Effects at Low Radiation Doses*, UNSCEAR 2000 Report, UNSCEAR, Vienna.
- Uryson, A.V. (2004) The maximum energy and spectra of cosmic rays accelerated in active galactic nuclei. *Astronomy Letters* 30:816–823.

- Usoskin, I.G., Mursula, K., Solanki, S.K., Schüssler, M., and Kovaltsov, G.A. (2002) A physical reconstruction of cosmic ray intensity since 1610. *J. Geophys. Res.* 107, doi:10.1029/2002JA009343.
- Wolfendale, A.W. (1979) Origin of cosmic rays. *Pramana* 12:631–651.
- Yao, W.-M., *et al.* (2006) Review of particle physics. *J. Phys. G* 33:1–1232. Also available online on the Particle Data Group pages at <http://pdg.lbl.gov>.
- Zatsepin, G.T. and Kuz'min, V.A. (1966) Upper limit of the spectrum of cosmic rays. *Journal of Experimental and Theoretical Physics Letters* 4:78–80.
- Ziegler, J.F. (1981) The background in detectors caused by sea level cosmic rays. *Nuclear Instruments and Methods* 191:419–424.
- Ziegler, J.F. (1996) Terrestrial cosmic rays. *IBM Journal of Research and Development* 40:19–39.
- Ziegler, J.F. (1998) Terrestrial cosmic ray intensities. *IBM Journal of Research and Development* 42:117–139.

Address reprint requests to:
Franco Ferrari
Institute of Physics and CASA*
University of Szczecin
ul. Wielkopolska 15
70-451 Szczecin
Poland

E-mail: ferrari@univ.szczecin.pl

Ewa Szuszkiewicz
Institute of Physics and CASA*
University of Szczecin
ul. Wielkopolska 15
70-451 Szczecin
Poland

E-mail: szusz@univ.szczecin.pl